



# ***Owner's Manual***

## **Original Instructions**

Cassette Type Air Conditioner



Thank you for choosing our product.

Please read this Owner's Manual carefully before operation and retain it for future reference.

If you have lost the Owner's Manual, please contact the local agent or visit [www.gree.com](http://www.gree.com) or send an email to [global@gree.com.cn](mailto:global@gree.com.cn) for the electronic version.

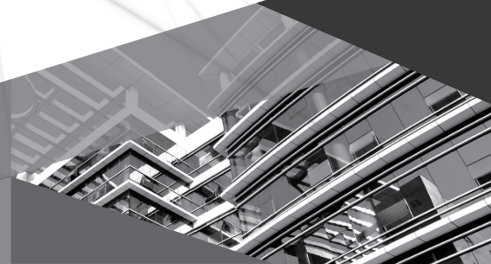

GKH(12)BB-K6DNA3A/I

GKH(18)BB-K6DNA3A/I

GKH(24)BC-K6DNA4A/I

# Contents

1 Safety Precautions .....	1
2 Outline of the Unit and Main Parts.....	3
3 Operation of remote controller.....	4
3.1 Buttons on remote controller .....	4
3.2 Introduction for icons on display screen.....	4
3.3 Introduction for buttons on remote controller.....	5
3.4 Function introduction for combination buttons.....	9
3.5 Operation guide.....	10
3.6 Replacement of batteries in remote controller.....	10
4 Preparative for Installation.....	11
4.1 Standard Accessory Parts .....	11
4.2 Selection of the Installation Location .....	11
4.3 Connection Pipe Requirement .....	12
4.4 Electrical Requirement .....	13
5 Installation of the Unit.....	14
5.1 Installation of the Indoor Unit.....	14
5.2 Installation of the Connection Pipe.....	16
5.3 Vacuum and Gas Leakage Inspection.....	20
5.4 Installation of the Drain Hose .....	22
5.5 The Panel Installation .....	25
5.6 Electrical Wiring.....	27
6 Installation of Controllers .....	31
7 Test Running.....	31
7.1 Trial Operation and Testing.....	31
8 Troubleshooting and Maintenance .....	34
8.1 Troubleshooting .....	34
8.2 Routine Maintenance .....	35
9 Safety operation of flammable refrigerant .....	37



This marking indicates that this product should not be disposed with other household wastes throughout the EU. To prevent possible harm to the environment or human health from uncontrolled waste disposal, recycle it responsibly to promote the sustainable reuse of material resources. To return your used device, please use the return and collection systems or contact the retailer where the product was purchased. They can take this product for environmental safe recycling.

---

Please read this operating manual carefully before operating the unit.



Appliance filled with flammable gas R32.



Before use the appliance, read the owner's manual first.



Before install the appliance, read the installation manual first.



Before repair the appliance, read the service manual first.

The figures in this manual may be different with the material objects, please refer to the material objects for reference.

## ● The Refrigerant

- To realize the function of the air conditioner unit, a special refrigerant circulates in the system. The used refrigerant is the fluoride R32, which is specially cleaned. The refrigerant is flammable and inodorous. Furthermore, it can leads to explosion under certain conditions. But the flammability of the refrigerant is very low. It can be ignited only by fire.
- Compared to common refrigerants, R32 is a nonpolluting refrigerant with no harm to the ozonosphere. The influence upon the greenhouse effect is also lower. R32 has got very good thermodynamic features which lead to a really high energy efficiency. The units therefore need a less filling.

### **WARNING:**



Do not use means to accelerate the defrosting process or to clean, other than those recommended by the manufacture. Should repair be necessary, contact your nearest authorized Service Centre. Any repairs carried out by unqualified personnel may be dangerous. The appliance shall be stored in a room without continuously operating ignition sources. (for example: open flames, an operating gas appliance or an operating electric heater.) Do not pierce or burn.

Appliance shall be installed, operated and stored in a room with a floor area larger than  $X \text{ m}^2$ . (Please refer to table "a" in section of " Safety Operation of Inflammable Refrigerant" for Space X.)

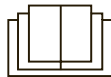
Appliance filled with flammable gas R32. For repairs, strictly follow manufacturer's instructions only. Be aware that refrigerants not contain odour. Read specialist's manual.



## 1 Safety Precautions

 <b>WARNING!</b>	This mark indicates procedures which, if improperly performed, might lead to the death or serious injury of the user.
 <b>CAUTION!</b>	This mark indicates procedures which, if improperly performed, might possibly result in personal harm to the user, or damage to property.

 <b>WARNING!</b>	
(1).	Installation should be left to the dealer or another professional. Improper installation may cause water leakage, electrical shock, or fire.
(2).	Install the air conditioner according to the instructions given in this manual. Incomplete installation may cause water leakage, electrical shock, or fire.
(3).	Be sure to use the supplied or specified installation parts. Use of other parts may cause the unit to come to lose, water leakage, electrical shock, or fire.
(4).	Install the air conditioner on a solid base that can support the weight of the unit. An inadequate base or incomplete installation may cause injury in the event the unit falls off the base.
(5).	Electrical work should be carried out in accordance with the installation manual and the national electrical wiring rules or code of practice. Insufficient capacity or incomplete electrical work may cause electrical shock or fire.
(6).	Be sure to use a dedicated power circuit. Never use a power supply shared by another appliance.
(7).	For wiring, use a cable length enough to cover the entire distance with no connection. Do not use an extension cord. Do not put other loads on the power supply, use a dedicated power circuit. (Failure to do so may cause abnormal heat, electric shock or fire.)
(8).	Use the specified types of wires for electrical connections between the indoor and outdoor units. Firmly clamp the interconnecting wires so their terminals receive no external stresses. Incomplete connections or clamping may cause terminal overheating or fire.
(9).	After connecting interconnecting and supply wiring be sure to shape the cables so that they do not put undue force on the electrical covers or panels. Install covers over the wires. Incomplete cover installation may cause terminal overheating, electrical shock, or fire.
(10).	If any refrigerant has leaked out during the installation work, ventilate the room. (The refrigerant produces a toxic gas if exposed to flames.)
(11).	After all installation is complete, check to make sure that no refrigerant is leaking out. (The refrigerant produces a toxic gas if exposed to flames.)
(12).	When installing or relocating the system, be sure to keep the refrigerant circuit free from substances other than the specified refrigerant (R32), such as air. (Any presence of air or other foreign substance in the refrigerant circuit causes an abnormal pressure rise or rupture, resulting in injury.)
(13).	During pump-down, stop the compressor before removing the refrigerant piping. If the compressor is still running and the stop valve is open during pump-down, air will be sucked in when the refrigerant piping is removed, causing abnormal pressure in the freezer cycle which will lead to breakage and even injury.

## DC Inverter Free match Series Cassette Type Unit

---

(14). During installation, attach the refrigerant piping securely before running the compressor. If the compressor is not attached and the stop valve is open during pump-down, air will be sucked in when the compressor is run, causing abnormal pressure in the freezer cycle which will lead to breakage and even injury.

(15). Be sure to establish an earth. Do not earth the unit to a utility pipe, arrester, or telephone earth. Incomplete earth may cause electrical shock, or fire. A high surge current from lightning or other sources may cause damage to the air conditioner.

(16). Be sure to install an earth leakage breaker. Failure to install an earth leakage breaker may result in electric shocks, or fire.

(17). This appliance is not intended for use by persons (including children) with reduced physical, sensory or mental capabilities, or lack of experience and knowledge, unless they have been given supervision or instruction concerning use of the appliance by a person responsible for their safety.

(18). Children should be supervised to ensure that they do not play with the appliance.

(19). If the supply cord is damaged, it must be replaced by the manufacturer, its service agent or similarly qualified persons in order to avoid a hazard.

(20). This appliance can be used by children aged from 8 years and above and persons with reduced physical, sensory or mental capabilities or lack of experience and knowledge if they have been given supervision or instruction concerning use of the appliance in a safe way and understand the hazards involved. Children shall not play with the appliance. Cleaning and user maintenance shall not be made by children without supervision.

### CAUTION!

(1). Do not install the air conditioner in a place where there is danger of exposure to inflammable gas leakage. If the gas leaks and builds up around the unit, it may catch fire.

(2). Establish drain piping according to the instructions of this manual. Inadequate piping may cause flooding.

(3). Tighten the flare nut according to the specified method such as with a torque wrench. If the flare nut is tightened too hard, the flare nut may crack after a long time and cause refrigerant leakage.

## 2 Outline of the Unit and Main Parts

Indoor

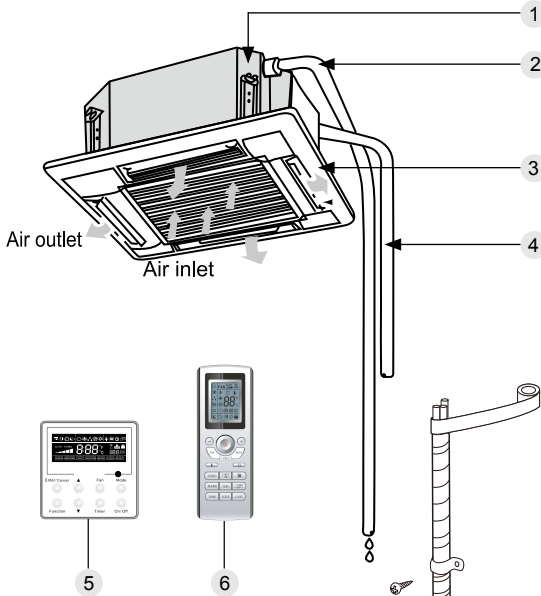

Outdoor

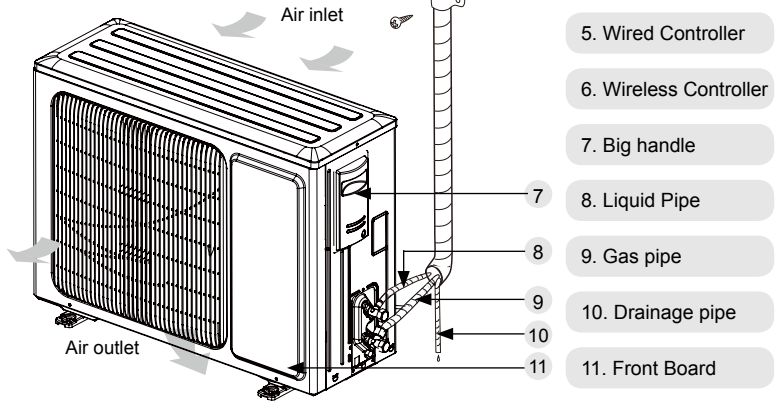

1. Drainage device
2. Drainage pipe
3. Air flow flap
4. Connection pipe
5. Wired Controller
6. Wireless Controller
7. Big handle
8. Liquid Pipe
9. Gas pipe
10. Drainage pipe
11. Front Board

Fig.1

### 3 Operation of remote controller

#### 3.1 Buttons on remote controller



- 1 ON/OFF button
- 2 MODE button
- 3 +/- button
- 4 FAN button
- 5 I FEEL button
- 6 ↑ button
- 7 🏠 button
- 8 🌬️ button
- 9 CLOCK button
- 10 TIMER ON/TIMER OFF button
- 11 X-FAN button  
Note: X-FAN is the same with BLOW
- 12 TEMP button
- 13 TURBO button
- 14 SLEEP button
- 15 LIGHT button

#### 3.2 Introduction for icons on display screen

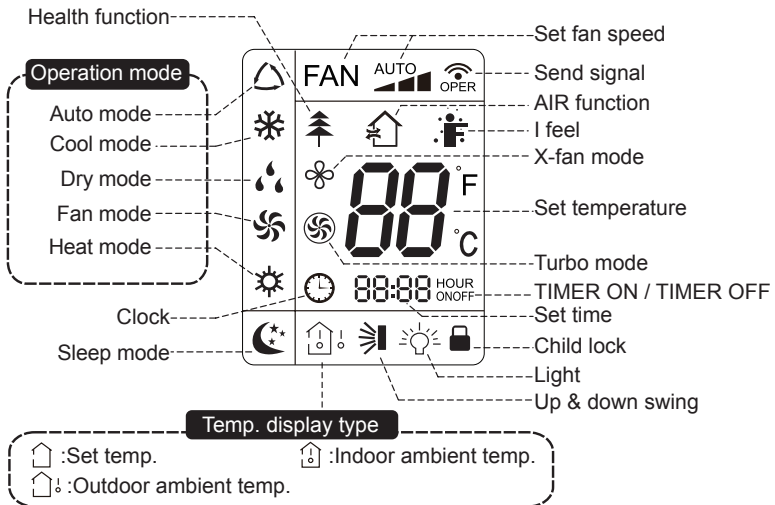



### 3.3 Introduction for buttons on remote controller

#### Note:

- This is a general use remote controller, it could be used for the air conditioners with multifunction; For some function, which the model doesn't have, if press the corresponding button on the remote controller that the unit will keep the original running status.
- After putting through the power, the air conditioner will give out a sound. After that, you can operate the air conditioner by using remote controller.

#### 1 ON/OFF button

Press this button can turn on or turn off the air conditioner. After turning on the air conditioner, operation indicator "⏻" on indoor unit's display is ON (green indicator. The colour is different for different models), and indoor unit will give out a sound.

#### 2 MODE button

Press this button to select your required operation mode.



- After selecting auto mode, air conditioner will operate automatically according to ambient temperature. Set temperature can't be adjusted and will not be displayed as well. Press "FAN" button can adjust fan speed. Press "↻" button can adjust fan blowing angle.
- After selecting cool mode, air conditioner will operate under cool mode. Press "+" or "-" button to adjust set temperature. Press "FN" button to adjust fan speed. Press "↻" button to adjust fan blowing angle.
- When selecting dry mode, the air conditioner operates at low speed under dry mode. Under dry mode, fan speed can't be adjusted. Press "↻" button to adjust fan blowing angle.
- When selecting fan mode, the air conditioner will only blow fan, no cooling and no heating. All indicators are OFF. Operation indicator is ON. Press "FAN" button to adjust fan speed. Press "↻" button to adjust fan blowing angle.
- When selecting heating mode, the air conditioner operates under heat mode. Press "+" or "-" button to adjust set temperature. Press "FAN" button to adjust fan speed. Press "↻" button to adjust fan blowing angle. (Cooling only unit won't receive heating mode signal. If setting heat mode with remote controller, press ON/OFF button can't start up the unit).

#### Note:

- For preventing cold air, after starting up heating mode, indoor unit will delay 1~5 minutes to blow air (actual delay time is depend on indoor ambient temperature).
- Set temperature range from remote controller: 16~30°C ; Fan speed: auto, low speed, medium speed, high speed.

**3** +/- button

- Press "+" or "-" button once increase or decrease set temperature 1°C . Holding "+" or "-" button, 2s later, set temperature on remote controller will change quickly. On releasing button after setting is finished, temperature indicator on indoor unit will change accordingly. (Temperature can't be adjusted under auto mode)
- When setting TIMER ON, TIMER OFF or CLOCK, press "+" or "-" button to adjust time. (Refer to CLOCK, TIMER ON, TIMER OFF buttons) When setting TIMER ON, TIMER OFF or CLOCK, press "+" or "-" button to adjust time. (Refer to CLOCK, TIMER ON, TIMER OFF buttons)

**4** FAN button

Pressing this button can set fan speed circularly as: auto (AUTO), low(▲) ,medium (▲▲), high(▲▲▲).

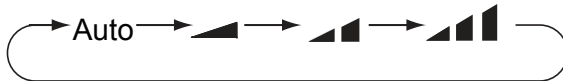

**Note:**

- Under AUTO Speed, IDU fan motor will adjust the fan speed (high, medium or low speed) according to ambient temperature.
- Fan speed under dry mode is low speed.

**5** I FEEL button

Press this button to start I FEEL function and "I FEEL" will be displayed on the remote controller. After this function is set, the remote controller will send the detected ambient temperature to the controller and the unit will automatically adjust the indoor temperature according to the detected temperature. Press this button again to close I FEEL function and "I FEEL" will disappear.

- Please put the remote controller near user when this function is set. Do not put the remote controller near the object of high temperature or low temperature in order to avoid detecting inaccurate ambient temperature.
- When I FEEL function is turned on, the remote controller should be put within the area where indoor unit can receive the signal sent by the remote controller.

**6** 🌿 button

Press this button to set HEALTH function ON or OFF. After the unit is turned on, it defaults to HEALTH function ON.

- This function is applicable to partial of models.









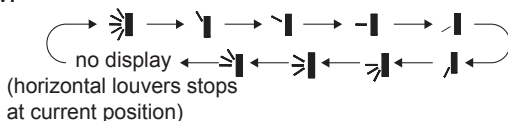

**7** 🏠 button

Press this button to select AIR function ON or OFF. (Only available for some models)



## 8 button

Press this button can select up&down swing angle. Fan blow angle can be selected circularly as below:





- When selecting "", air conditioner is blowing fan automatically. Horizontal louver will automatically swing up & down at maximum angle.
- When selecting ", , , , ", air conditioner is blowing fan at fixed position. Horizontal louver will stop at the fixed position.
- When selecting ", , ", air conditioner is blowing fan at fixed angle. Horizontal louver will send air at the fixed angle.
- Hold "" button above 2s to set your required swing angle. When reaching your required angle, release the button.

### Note:

- ", , " may not be available. When air conditioner receives this signal, the air conditioner will blow fan automatically.

## 9 CLOCK button

Press this button to set clock time. "" icon on remote controller will blink. Press "+" or "-" button within 5s to set clock time. Each pressing of "+" or "-" button, clock time will increase or decrease 1 minute. If hold "+" or "-" button, 2s later, time will change quickly. Release this button when reaching your required time. Press "CLOCK" button to confirm the time. "" icon stops blinking.

### Note:

- Clock time adopts 24-hour mode.
- The interval between two operation can't exceeds 5s. Otherwise, remote controller will quit setting status. Operation for TIMER ON/TIMER OFF is the same.

## 10 TIMER ON / TIMER OFF button

- TIMER ON button

"TIMER ON" button can set the time for timer on. After pressing this button, "" icon disappears and the word "ON" on remote controller blinks. Press "+" or "-" button to adjust TIMER ON setting. After each pressing "+" or "-" button, TIMER ON setting will increase or decrease 1min. Hold "+" or "-" button, 2s later, the time will change quickly until reaching your required time.

Press "TIMER ON" to confirm it. The word "ON" will stop blinking. "" icon resumes displaying. Cancel TIMER ON: Under the condition that TIMER ON is

started up, press "TIMER ON" button to cancel it.

● **TIMER OFF button**

"TIMER OFF" button can set the time for timer off. After pressing this button, "🕒" icon disappears and the word "OFF" on remote controller blinks. Press "+" or "-" button to adjust TIMER OFF setting. After each pressing "+" or "-" button, TIMER OFF setting will increase or decrease 1min. Hold "+" or "-" button, 2s later, the time will change quickly until reaching your required time.

Press "TIMER OFF" word "OFF" will stop blinking. "🕒" icon resumes displaying. Cancel TIMER OFF. Under the condition that TIMER OFF is started up, press "TIMER OFF" button to cancel it.

**Note:**

- Under on and off status, you can set TIMER OFF or TIMER ON simultaneously.
- Before setting TIMER ON or TIMER OFF, please adjust the clock time.
- After starting up TIMER ON or TIMER OFF, set the constant circulating valid. After that, air conditioner will be turned on or turned off according to setting time. ON/OFF button has no effect on setting. If you don't need this function, please use remote controller to cancel it.

**11** X-FAN button

Press this button under cool and dry mode to start up x-fan function, and "🌀" icon on remote controller will be displayed. Press this button again to cancel x-fan function, and "🌀" icon will disappear.

**Note:**

- When x-fan function is on, if the air conditioner is turned off, indoor fan will still operate at low speed for a while to blow the residual water inside the air duct.
- During x-fan operation, press X-FAN button to turn off x-fan function. Indoor fan will stop operation immediately.

**12** TEMP button

By pressing this button, you can see indoor set temperature, indoor ambient temperature or outdoor ambient temperature on indoor unit's display. The setting on remote controller is selected circularly as below:

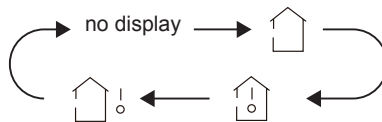



- When selecting "🏠🌡️" or no display with remote controller, temperature indicator on indoor unit displays set temperature.
- When selecting "🏠🌡️☀️" with remote controller, temperature indicator on indoor unit displays indoor ambient temperature.

- When selecting "," with remote controller, temperature indicator on indoor unit displays outdoor ambient temperature.



### Note:

- Outdoor temperature display is not available for some models. At that time, indoor unit receives "" signal, while it displays indoor set temperature.
- It's defaulted to display set temperature when turning on the unit. There is no display in the remote controller.
- Only for the models whose indoor unit has dual-8 display.
- When selecting displaying of indoor or outdoor ambient temperature, indoor temperature indicator displays corresponding temperature and automatically turn to display set temperature after three or five seconds.



## 13 TURBO button

Under COOL or HEAT mode, press this button to turn to quick COOL or quick HEAT mode. "" icon is displayed on remote controller. Press this button again to exit turbo function and "" icon will disappear.

## 14 SLEEP button



Under COOL, HEAT mode, press this button to start up sleep function. "" icon is displayed on remote controller. Press this button again to cancel sleep function and "" icon will disappear.

## 15 LIGHT button

Press this button to turn off display light on indoor unit. "" icon on remote controller disappears. Press this button again to turn on display light. "" icon is displayed.

### 3.4 Function introduction for combination buttons

#### Child lock function

Press "+" and "-" simultaneously to turn on or turn off child lock function. When child lock function is on, "" icon is displayed on remote controller. If you operate the remote controller, the "" icon will blink three times without sending signal to the unit.

#### Temperature display switchover function

Under OFF status, press "-" and "MODE" buttons simultaneously to switch temperature display between °C and °F .

### 3.5 Operation guide

1. After putting through the power, press "ON/OFF" button on remote controller to turn on the air conditioner.
2. Press "MODE" button to select your required mode: AUTO, COOL, DRY, FAN, HEAT.
3. Press "+" or "-" button to set your required temperature. (Temperature can't be adjusted under auto mode).
4. Press "FAN" button to set your required fan speed: auto, low, medium and high speed.
5. Press "↻" button to select fan blowing angle.

### 3.6 Replacement of batteries in remote controller

1. Press the back side of remote controller marked with "OPEN", as shown in the fig, and then push out the cover of battery box along the arrow direction.
2. Replace two 7# (AAA 1.5V) dry batteries, and make sure the position of "+" polar and "-" polar are correct.
3. Reinstall the cover of battery box.

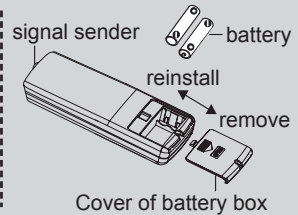

### NOTICE















- During operation, point the remote control signal sender at the receiving window on indoor unit.
- The distance between signal sender and receiving window should be no more than 8m, and there should be no obstacles between them.
- Signal may be interfered easily in the room where there is fluorescent lamp or wireless telephone; remote controller should be close to indoor unit during operation.
- Replace new batteries of the same model when replacement is required.
- When you don't use remote controller for a long time, please take out the batteries.
- If the display on remote controller is fuzzy or there's no display, please replace batteries.

## 4 Preparative for Installation

### 4.1 Standard Accessory Parts

The standard accessory parts listed below are furnished and should be used as required.

Table 1

Indoor Unit Accessories				
No.	Name	Appearance	Q'ty	Usage
1	Drain Hose		1	To connect with the hard PVC drain pipe
2	Nut with Washer		4	To fix the hook on the cabinet of the unit.
3	Washer		10	To be used together with the hanger bolt for installing the unit.
4	installation paperboard		1	used for ceiling drilling
5	Gasket mounting board		4	Used to prevent gasket from falling off
6	Wireless Controller +Battery		1+2	To control the indoor unit
7	sealing plaster		1	
8	Fastener		4	To fasten the sponge
9	Insulation		1	To insulate the gas pipe
10	Insulation		1	To insulate the liquid pipe
11	Sponge		4	To insulate the drain pipe
12	Nut		1	To connect gas pipe
13	Nut		1	To connect liquid pipe
14	Enswathement		2	

### 4.2 Selection of the Installation Location

 **WARNING!**

The unit must be installed where strong enough to withstand the weight of the unit and fixed securely, otherwise the unit would topple or fall off.

 **CAUTION!**

- ① . Do not install where there is the danger of combustible gas leakage.
- ② . Do not install the unit near heat source of heat, steam, or flammable gas.
- ③ . Children under 10 years old must be supervised not to operate the unit.

Decide the installation location with the customer as follows:

### 4.2.1 Indoor Unit

Select an installation site where the following conditions are fulfilled and that meets your customer's approval.

- (1). Obstruct should be put away from the intake or outlet vent of the indoor unit so that the airflow can be blown through all the room.
- (2). Make sure that the installation meets the requirement of the schematic diagram of installation spaces.
- (3). Select the place where can stand 4 times of the weight of the indoor unit and would not increase the operating noise and vibration.
- (4). The horizontality of the installation place should be guaranteed.
- (5). Select the place where is easy to drain out the condensate water, and connect with outdoor unit.
- (6). Make sure that there are enough space for care and maintenance, and the height fall between the indoor unit and ground is above 1800mm.
- (7). When installing the suspension bolt, check if the installation place can stand 4 times of the weight of the unit. If not, reinforce it before installation.

Note: There will be large amount of greasy dirt accumulated on the fan, heat exchanger and water pump located in the dining room and kitchen, which would reduce the capacity of the heater exchanger, lead to leakage and abnormal operation of the water pump.

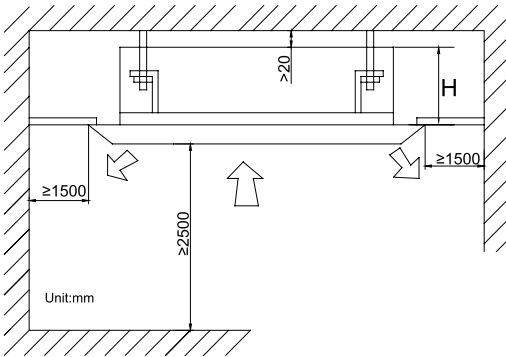

Fig.2

Table 2

Models	H(mm)
GKH(12)BB-K6DNA3A/I	255
GKH(18)BB-K6DNA3A/I	255
GKH(24)BC-K6DNA4A/I	260

### 4.3 Connection Pipe Requirement



The maximum length of the connection pipe is listed in the table below. Do not place the units between which the distance exceeds the maximum length of the connection pipe.



Table 3

Model \ Item	Size of Fitting Pipe(Inch)		Max. Pipe Length (m)	Max. Height Difference between Indoor Unit and Outdoor Unit (m)	Drainage pipe(Outer Diameter × wall thickness) (mm)
	Liquid	Gas			
GKH(12)BB-K6DNA3A/I	1/4	3/8	20	15	Φ25×1.5
GKH(18)BB-K6DNA3A/I		1/2	20	15	
GKH(24)BC-K6DNA4A/I	3/8	5/8	30	15	

The connection pipe should be insulated with proper water-proof insulating material.

The pipe wall thickness shall be 0.5-1.0mm and the pipe wall shall be able to withstand the pressure of 6.0 MPa. The longer the connecting pipe, the lower the cooling and heating effect performs.

## 4.4 Electrical Requirement

Electric Wire Size and Fuse Capacity.

Table 4

Indoor Units	Power Supply	Fuse Capacity	Min. Power Supply Cord
	V/Ph/Hz	A	mm <sup>2</sup>
12~24k	220-240V~ 50Hz	5	0.75

Notes:

- ① . The fuse is located on the main board.
- ② . Install the disconnect device with a contact gap of at least 3mm in all poles nearby the units (Both indoor unit and outdoor unit).The appliance must be positioned so that the plug is accessible.
- ③ . The specifications of the power cable listed in the table above are determined based on the maximum power (maximum amps) of the unit.
- ④ . The specifications of the power cable listed in the table above are applied to the conduit-guarded multi-wire copper cable (like, YJV copper cable, consisting of PE insulated wires and a PVC cable jacket) used at 40°C and resistible to 90°C(see IEC 60364-5-52). If the working condition changes, they should be modified according to the related national standard.

## 5 Installation of the Unit

### 5.1 Installation of the Indoor Unit

#### 5.1.1 Indoor unit dimension

For the units: 12-18k

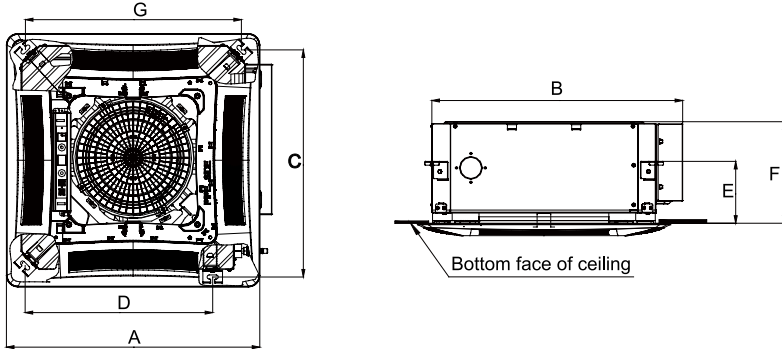

For the units: 24k

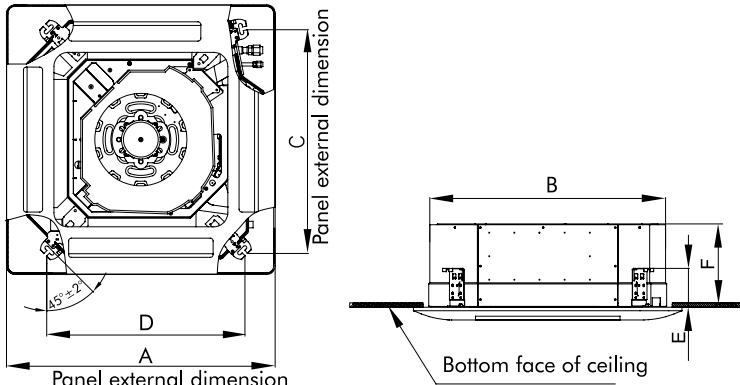

Fig.3  
Table 5

Item	A	B	C	D	E	F	G
GKH(12)BB-K6DNA3A/I	670	666	600	496	145	240	596
GKH(18)BB-K6DNA3A/I							
GKH(24)BC-K6DNA4A/I	950	840	780	680	145	240	-

5.1.2 Installing the Main Body Unit

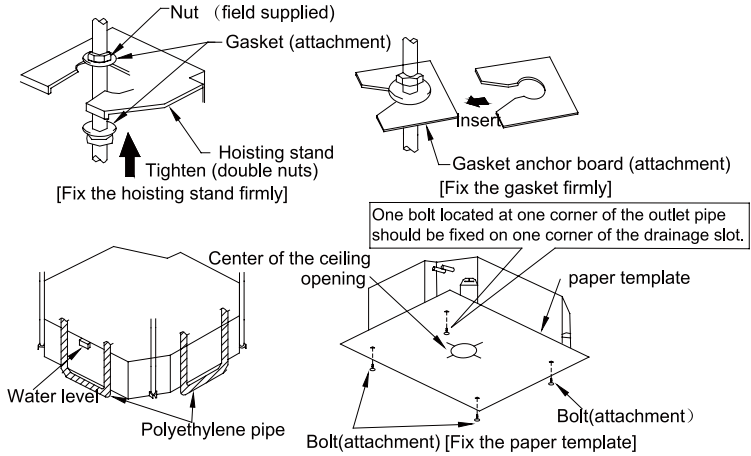

Fig.4

- (1). Install the hoisting stand on the hoisting screw by using nuts and gaskets at both the upper and lower sides of the hoisting stand. To prevent the gasket from breaking off, a gasket anchor board can be helpful.
- (2). Install the paper template on the unit, and fix the drain pipe at the outlet vent.
- (3). Adjust the unit to the best position.
- (4). Check if the unit is installed horizontally at four directions. If not, the water pump and the float switch would function improperly and even lead to water leakage.
- (5). Remove the gasket anchor board and tighten the nut remained.
- (6). Remove the paper template.

5.1.3 Installing the Suspension Bolts

- (1). Using the installation template, drill holes for bolts (four holes). (Fig. 5)
- (2). Install the bolts to the ceiling at a place strong enough to hang the unit. Mark the bolt positions from the installation template. With a concrete drill, drill for 12.7mm (1/2") diameter holes. (Fig.6)
- (3). Insert the anchor bolts into the drilled holes, and drive the pins completely into the anchor bolts with a hammer. (Fig.7)

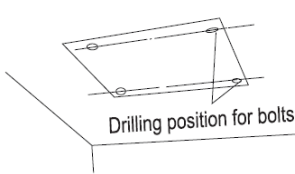

Fig.5

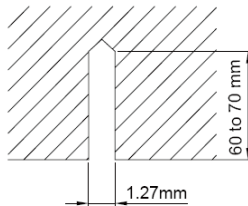

Fig.6

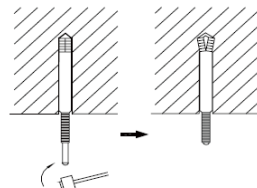

Fig.7

### 5.1.4 Leveling

The water level test must be done after installing the indoor unit to make the unit is horizontal, as shown below.

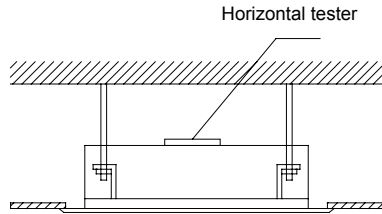

Fig.8

## 5.2 Installation of the Connection Pipe

### 5.2.1 Flare Processing

- (1). Cut the connection pipe with the pipe cutter and remove the burrs.
- (2). Hold the pipe downward to prevent cuttings from entering the pipe.
- (3). Remove the flare nuts at the stop valve of the outdoor unit and inside the accessory bag of the indoor unit, then insert them to the connection pipe, after that, flare the connection pipe with a flaring tool.
- (4). Check if the flare part is spread evenly and there are no cracks (see Fig.9).

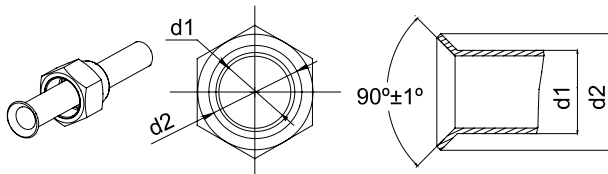

Fig.9

5.2.2 Bending Pipes

(1). The pipes are shaped by your hands. Be careful not to collapse them.

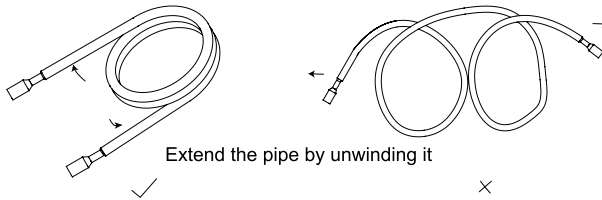

Fig.10

- (2). Do not bend the pipes in an angle more than 90°.
- (3). When pipes are repeatedly bent or stretched, the material will harden, making it difficult to bend or stretch them any more. Do not bend or stretch the pipes more than three times.
- (4). When bending the pipe, do not bend it as is. The pipe will be collapsed. In this case, cut the heat insulating pipe with a sharp cutter as shown in Fig.11, and bend it after exposing the pipe. After bending the pipe as you want, be sure to put the heat insulating pipe back on the pipe, and secure it with tape.

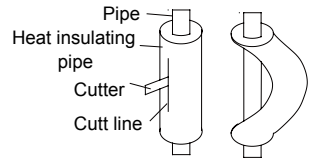

Fig.11

<b>⚠ CAUTION!</b>
① . To prevent breaking of the pipe, avoid sharp bends. Bend the pipe with a radius of curvature of 150 mm or over.
② . If the pipe is bent repeatedly at the same place, it will break.

5.2.3 Connecting the Pipe at the Indoor Unit Side

Detach the caps and plugs from the pipes.

<b>⚠ CAUTION!</b>
① . Be sure to apply the pipe against the port on the indoor unit correctly. If the centering is improper, the flare nut cannot be tightened smoothly. If the flare nut is forced to turn, the threads will be damaged.
② . Do not remove the flare nut until the connection pipe is to be connected so as to prevent dust and impurities from coming into the pipe system.

When connecting the pipe to the unit or removing it from the unit, please do use both the spanner and the torque wrench.(Fig.12)

When connecting, smear both inside and outside of the flare nut with refrigeration oil, screw it hand tight and then tighten it with the spanner.

Refer to Table 6 to check if the wrench has been tightened properly (too tight would mangle the nut and lead to leakage).

Examine the connection pipe to see if it leaks, then take the treatment of heat insulation, as shown in the Fig.12.

Use the medium-sized sponge to insulate the coupler of the gas pipe.

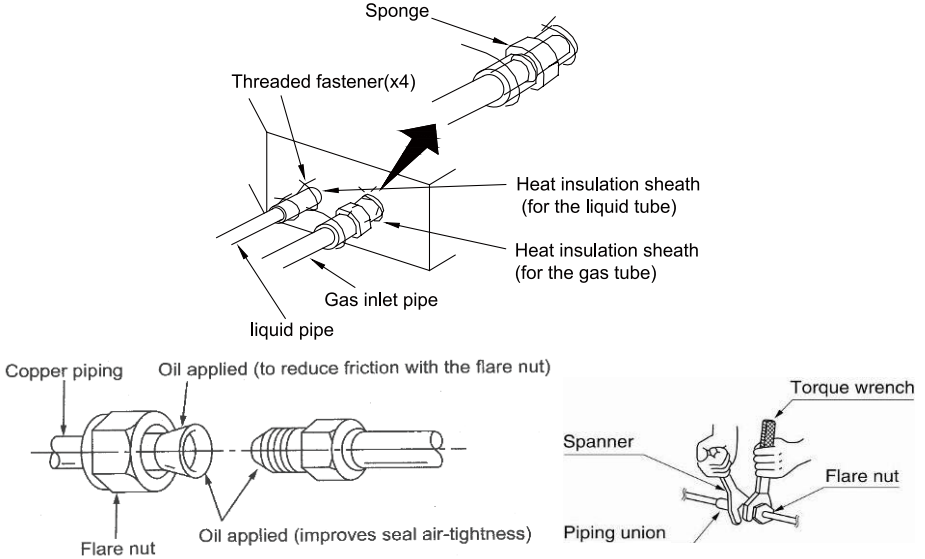

Fig.12

Table 6 Flare nut tightening torque

Pipe Diameter	Tightening Torque
1/4"(Inch)	15-30 (N·m)
3/8"(Inch)	35-40 (N·m)
5/8"(Inch)	60-65 (N·m)
1/2"(Inch)	45-50 (N·m)
3/4"(Inch)	70-75 (N·m)
7/8"(Inch)	80-85 (N·m)



Be sure to connect the gas pipe after connecting the liquid pipe completely.

5.2.4 Connecting the Pipe at the Outdoor Side Unit

Tighten the flare nut of the connection pipe at the outdoor unit valve connector. The tightening method is the same as that as at the indoor side.

5.2.5 Checking the Pipe Connections for Gas Leaking

For both indoor and outdoor unit side, check the joints for gas leaking by the use of a gas leakage detector without fail when the pipes are connected.

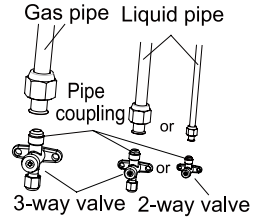

Fig.13

5.2.6 Heat Insulation on the Pipe Joints (Indoor Side Only)

Stick coupler heat insulation (large and small) to the place where connecting pipes.

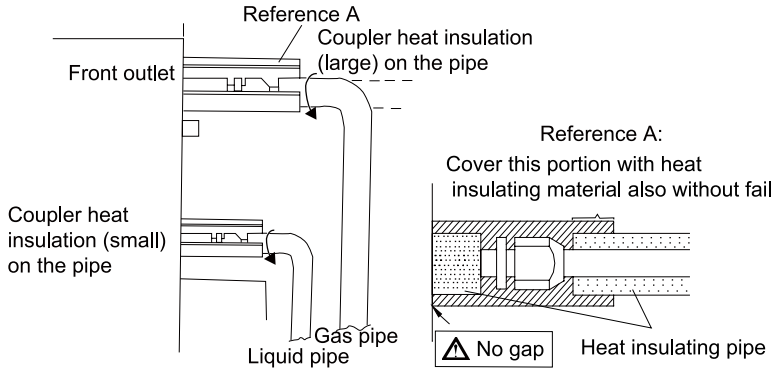

Fig.14

5.2.7 Liquid Pipe and Drain Pipe

If the outdoor unit is installed lower than the indoor unit (See Fig.15)

- (1). A drain pipe should be above ground and the end of the pipe does not dip into water. All pipes must be restrained to the wall by saddles.
- (2). Taping pipes must be done from bottom to top.
- (3). All pipes are bound together by tape and restrained to wall by saddles.

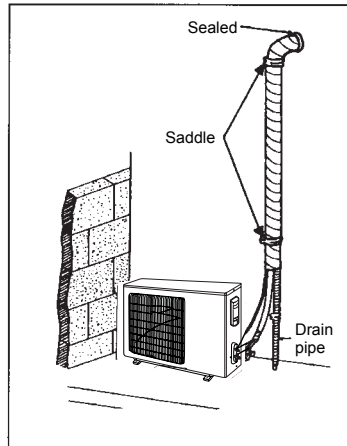

Fig.15

If the outdoor unit is installed higher than the indoor unit (See Fig.16)

- (1). Taping should be done from lower to the upper part.
- (2). All pipes are bound and taped together and also should be trapped to prevent water from returning to the room.
- (3). Restraint all pipes to the wall with saddles.

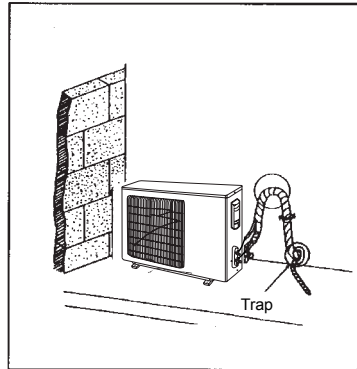
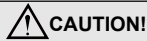

Fig.16

## 5.3 Vacuum and Gas Leakage Inspection



Do not purge the air with refrigerants but use a vacuum pump to vacuum the installation! There is no extra refrigerant in the outdoor unit for air purging!

### 5.3.1 Vacuum

- (1). Remove the caps of the liquid valve, gas valve and also the service port.
- (2). Connect the hose at the low pressure side of the manifold valve assembly to the service port of the unit's gas valve, and meanwhile the gas and liquid valves should be kept closed in case of refrigerant leak.
- (3). Connect the hose used for evacuation to the vacuum pump.
- (4). Open the switch at the lower pressure side of the manifold valve assembly and start the vacuum pump. Meanwhile, the switch at the high pressure side of the manifold valve assembly should be kept closed, otherwise evacuation would fail.
- (5). The evacuation duration depends on the unit's capacity, generally, 15 minutes for the 12k units, 20 minutes for the 18k units, 30 minutes for the 24 units. And verify if the pressure gauge at the low pressure side of the manifold valve assembly reads  $-1.0\text{Mp}$  ( $-75\text{cmHg}$ ), if not, it indicates there is leak somewhere. Then, close the switch fully and then stop the vacuum pump.
- (6). Wait for some time to see if the system pressure can remain unchanged, 3 minutes for the units less than 18k, 5 minutes for the 18K~24k units. During this time, the reading of the pressure gauge at the low pressure side can not be larger than  $0.005\text{Mp}$  ( $0.38\text{cmHg}$ ).



- (7). Slightly open the liquid valve and let some refrigerant go to the connection pipe to balance the pressure inside and outside of the connection pipe, so that air will not come into the connection pipe when removing the hose. Note that the gas and liquid valve can be opened fully only after the manifold valve assembly is removed.
- (8). Place back the caps of the liquid valve, gas valve and also the service port.

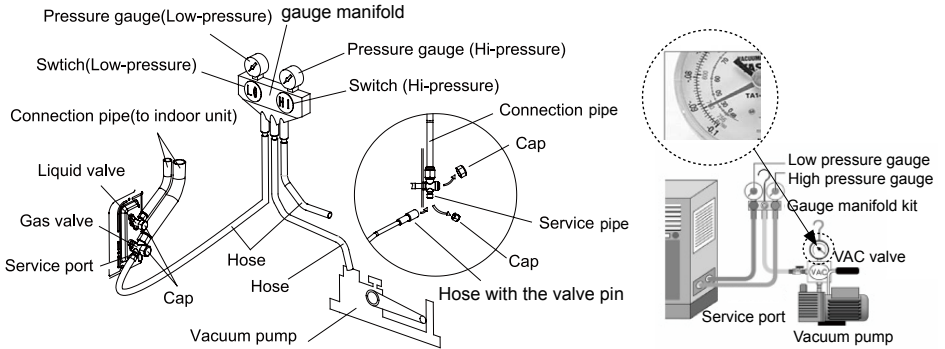

Fig.17

Note: For the large-sized unit, it has the service port for both the gas valve and the liquid valve. During evacuation, it is available to connect two hoses of the manifold valve assembly to two service ports to quicken the evacuating speed.

## 5.4 Installation of the Drain Hose

### 5.4.1 Installation of Drain Piping

- (1). Keep piping as short as possible and slope it downwards at a gradient of at least 1/100 so that air may not remain trapped inside the pipe.
- (2). Keep pipe size equal to or greater than that of the connecting pipe.
- (3). Install the drain piping as shown and take measures against condensation. Improperly rigged piping could lead to leaks and eventually wet furniture and belongings.

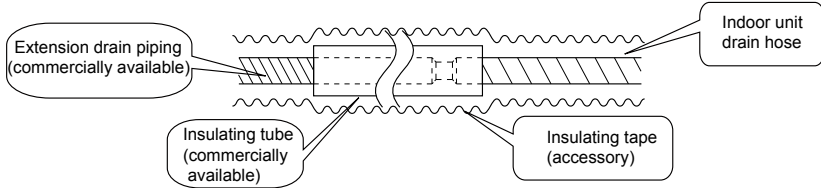

Fig.19

### 5.4.2 Installing the Drain Pipes

- (1). Insert the drain pipe to the drain outlet of the unit and then tighten the clamp securely with tape.
- (2). Connect the extension drain pipe to the drain pipe and then tighten the clamp with tape.

<p>During the installation, distance from soft drain pipe to the gasket is <math>A</math>mm when the bolt is tightened. It is not allowed to apply PVC or other related glue in the joints of two ends of drain pipe.</p> <p>Metal clamp Drain hose (accessory) Grey tape (accessory)</p>	<p>Insulate the pipe clamp and the drain hose using heat insulation sponge.</p> <p>Metal clamp (accessory) Insulation sponge (accessory)</p>

Indoor Unit	A
GKH(12)BB-K6DNA3A/I	10±2mm(2/5±2/25inch)
GKH(18)BB-K6DNA3A/I	
GKH(24)BC-K6DNA4A/I	15±3mm(3/5±1/10inch)

- (3). When unifying multiple drain pipes, install the pipes as Fig.20. Select converging drain pipes whose gauge is suitable for the operating capacity of the unit.(take the cassette type unit for example)

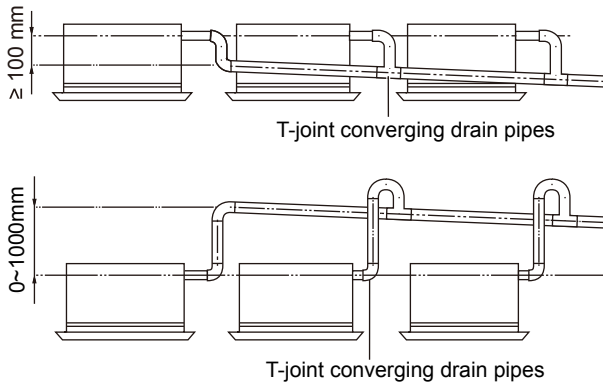

Fig.20

- (4). When the drain hose cannot keep a sufficient gradient, it is necessary to fit a riser pipe (field supplied) to it.
- (5). If the air flow of indoor unit is high, this might cause negative pressure and result in return suction of outdoor air. Therefore, U-type water trap shall be designed on the drainage side of each indoor unit.(Fig.21)
- (6). Install one water trap for each unit.
- (7). Installation of water trap shall consider easy cleaning in the future.

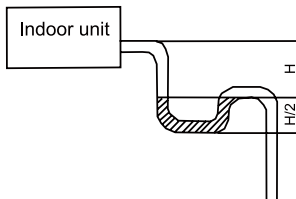

Fig.21

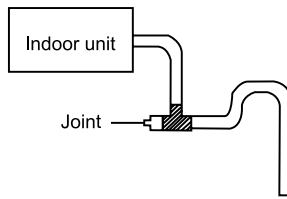

Fig.22

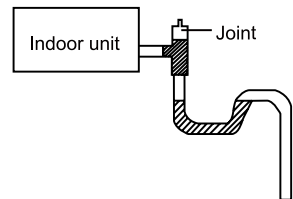

Fig.23

- (8). Connection of drainage branch pipe to the standpipe or horizontal pipe of drainage main pipe

The horizontal pipe cannot be connected to the vertical pipe at a same height. It can be connected in a manner as shown below:

NO.1: Attach the 3-way connection of the drainage pipe joint as shown in Fig.24.

NO.2: Attach the drain elbow as shown in Fig.25.

NO.3: Attach the horizontal pipe as shown in Fig.26.

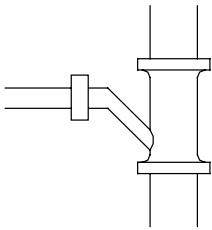

3-way connection of drainage pipe joint

Fig.24

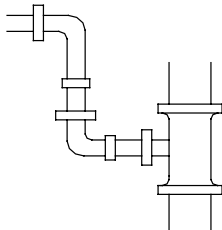

Connection of drain elbow

Fig.25

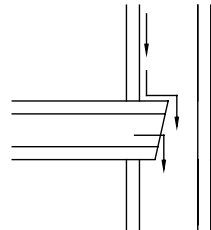

Connection of horizontal pipe

Fig.26

### 5.4.3 Precautions When Doing Riser Piping Work

(1). Make sure that heat insulation work is executed on the following 2 spots to prevent any possible water leakage due to dew condensation.

- 1). Connect the drain hose to the drain lift pipe, and insulate them.
- 2). Connect the drain hose to the drain outlet on the indoor unit, and tighten it with the clamp.

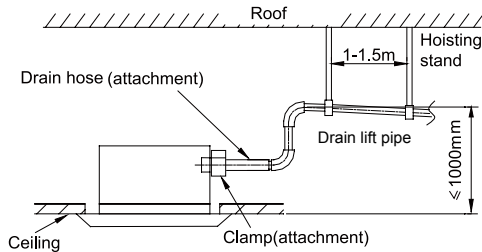
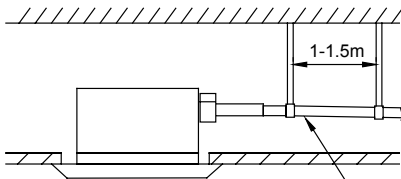
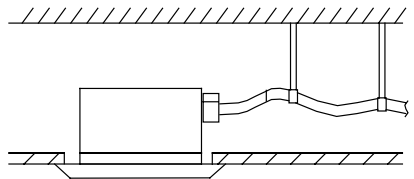

Fig.27

(4). Secure a downward gradient of 1/100 or more for the drain pipe. To accomplish this, mount supporting brackets at an interval of 1 -1.5 m.



✓ (Correct) 1/100 or more gradient



× (wrong)

Fig.28

(5). The incline of attached drain hose should be 75 mm or less so that the drain outlet does not have to withstand additional force.

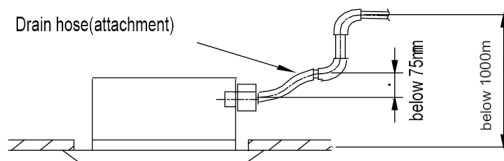

Fig.29

## 5.4.4 Testing of Drain Piping

After piping work is finished, check if drainage flows smoothly.

Shown in the Fig.30, Add approximately 1liter of water slowly into the drain pan and check drainage flow during COOL running.

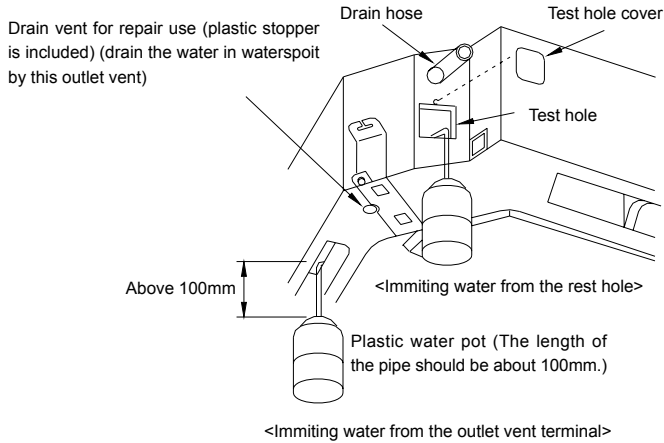

Fig.30

## 5.5 The Panel Installation

### 5.5.1 Precautions

- (1). See the figure below for the relationship of the front panel and the connecting pipe.

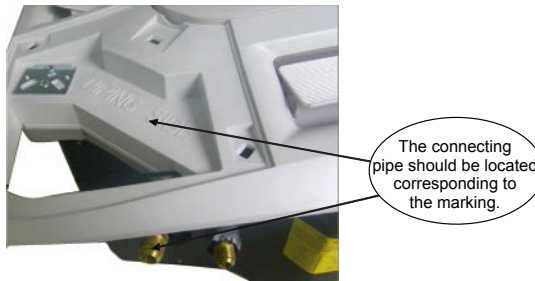

Fig.31

- (2). Improper screwing of the screws may cause the troubles shown in Fig.32.

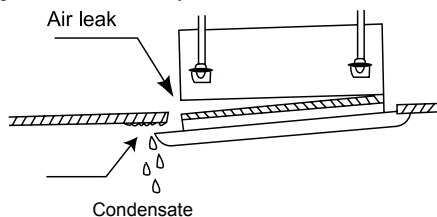

Fig.32

- (3). If gap still exists between ceiling and decoration panel after tightening the screws, readjust the height of the indoor unit. (Fig.33)

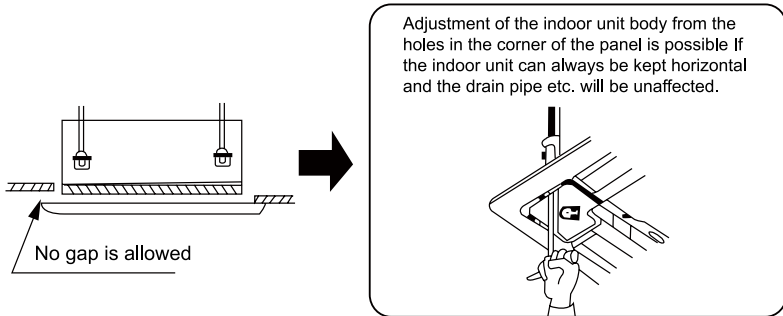

Fig.33

- (4). Wire the swing flap motor as shown in Fig.34.

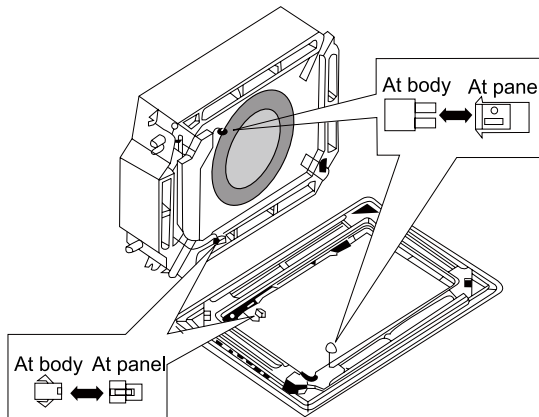

Fig.34

### 5.5.2 Installing the Panel

- (1). Place the panel at the unit, and latch the hooks beside and opposite the swing flap motor.
- (2). Latch other two hooks.
- (3). Tighten four hexagonal screws under the latches about 15mm.
- (4). Adjust the panel along the direction indicated by the arrow as shown in Fig.35.
- (5). Tighten the screws until the thickness of the sealing material between the panel and the indoor unit reduces to 5-8cm.

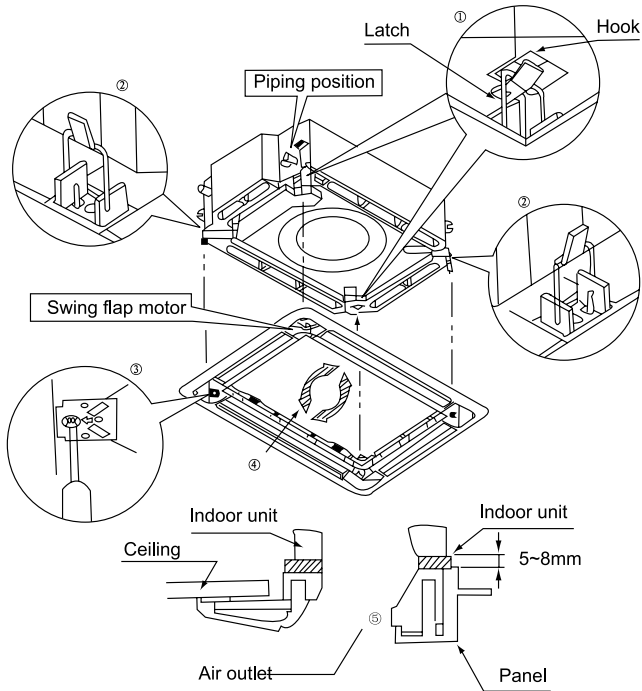

Fig.35

## 5.6 Electrical Wiring

### 5.6.1 Wiring Precautions



- |  |
|--|
| <b>⚠ WARNING!</b>  |
| ① . Before obtaining access to terminals, all supply circuits must be disconnected.  |
| ② . The rated voltage of the unit is as shown as Table 4   |
| ③ . Before turning on, verify that the voltage is within the 198~264V range(for single phase unit) or 342~457V range (for three-phase unit).   |
| ④ . Always use a special branch circuit and install a special receptacle to supply power to the air conditioner.   |
| ⑤ . The special branch circuit breaker is installed in the permanent wiring. Always use a circuit that can trip all the poles of the wiring and has an isolation distance of at least 3mm between the contacts of each pole. |
| ⑥ . Perform wiring work in accordance with standards so that the air conditioner can be operated safely and positively.  |
| ⑦ . Install a leakage special branch circuit breaker in accordance with the related laws and regulations and electric company standards.   |

**CAUTION!**

- ① . The power source capacity must be the sum of the air conditioner current and the current of other electrical appliances. When the current contracted capacity is insufficient, change the contracted capacity.
- ② . When the voltage is low and the air conditioner is difficult to start, contact the power company to raise the voltage.

**5.6.2 Electrical Wiring**

(1). For solid core wiring (Fig.36)

- 1). Cut the wire end with a wire cutter or wire-cutting pliers, then strip the insulation about 25 mm (15/16") .
- 2). Using a screwdriver, remove the terminal screw(s) on the terminal board.
- 3). Using pliers, bend the solid wire to form a loop suitable for the terminal screw.
- 4). Shape the loop wire properly, place it on the terminal board and tighten securely with the terminal screw using a screwdriver.

(2). For strand wiring (Fig.36)

- 1). Cut the wire end with a wire cutter or wire-cutting pliers, then strip the insulation about 10 mm (3/8") .
- 2). Using a screwdriver, remove the terminal screw (s) on the terminal board.
- 3). Using a round terminal fastener or pliers, securely clamp a round terminal to each stripped wire end.
- 4). Position the round terminal wire, and replace and tighten the terminal screw with a screwdriver.(Fig.37)

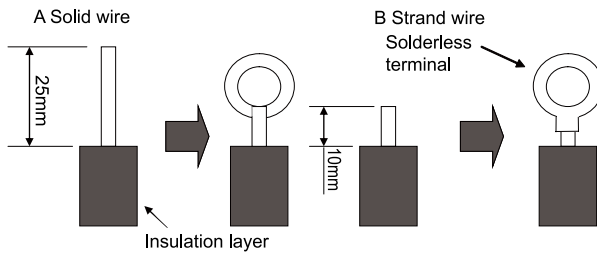

Fig.36

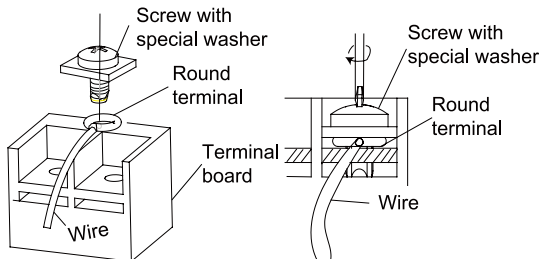

Fig.37

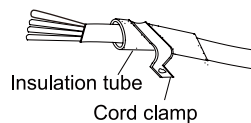

Fig.38



(3). How to fix connection cord and power cord by cord clamp

After passing the connection cord fasten it with the cord clamp.(Fig.38)



- |  |
|--|
| ① . Before starting work, check that power is not being supplied to the indoor unit and outdoor unit.  |
| ② . Match the terminal block numbers and connection cord colors with those of the indoor unit side.  |
| ③ . Erroneous wiring may cause burning of the electric parts.  |
| ④ . Connect the connection cords firmly to the terminal block. Imperfect installation may cause a fire.  |
| ⑤ . Always fasten the outside covering of the connection cord with cord clamps. (If the insulator is not clamped, electric leakage may occur.) |
| ⑥ . Always connect the ground wire.  |

(4). Electric wiring between the indoor and outdoor units

Single-phase units(12~24k)

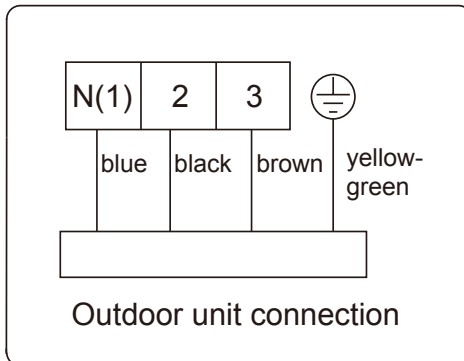

(5). Electric wiring of indoor unit side

Remove the electric box cover from the electric box sub-assy and then connect the wire.

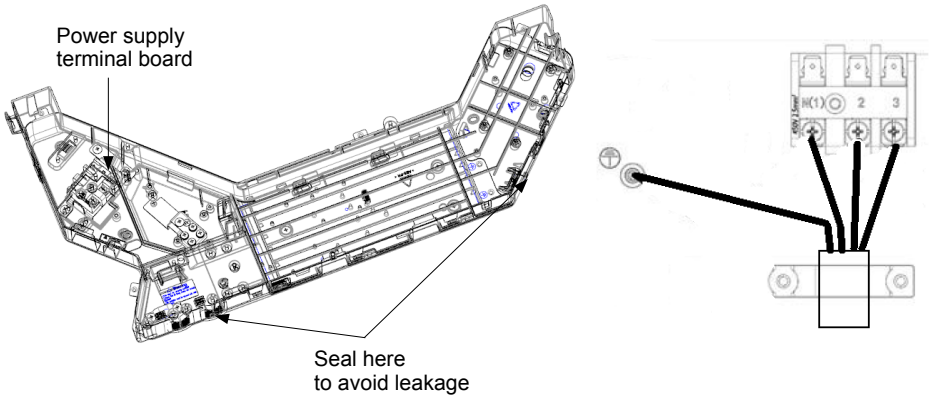
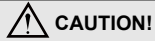

Fig.39



- |   |
|---|
| ① . Tighten the power cord respectively on the terminal boards with screws. Faulty connection may cause a fire. |
| ② . If the power supply are wired incorrectly, the air conditioner may be damaged.                              |
| ③ . Connect the indoor unit connection cord properly based on the corresponding marks as shown in Fig.39.       |
| ④ . Ground both the indoor and outdoor units by attaching a ground wire.  |
| ⑤ . Unit shall be grounded in compliance with the applicable local and national codes.                          |

## 6 Installation of Controllers

Refer to the Installation Manual of the controller for more details.

## 7 Test Running

### 7.1 Trial Operation and Testing

- (1). The meaning of error codes as shown below:

Table 8

Number	Error code	Error
1	E1	Compressor high pressure protection
2	E2	Indoor anti-freeze protection
3	E3	Compressor low pressure protection, refrigerant lack protection and refrigerant collecting mode
4	E4	Compressor high discharge temperature protection
5	E5	AC over-current protection
6	E6	Communication error
7	E7	Mode conflict
8	E8	Anti-high temperature protection
9	E9	Full water protection
10	F1	Indoor ambient temperature sensor is open/short circuited
11	F2	Indoor evaporator temperature sensor is open/short circuited
12	F3	Outdoor ambient temperature sensor is open/short circuited
13	F4	Outdoor condenser temperature sensor is open/short circuited
14	F5	Outdoor discharge temperature sensor is open/short circuited
15	C5	Jumper cap malfunction protection
16	EE	Loading EEPROM malfunction

**Note:** If there're other error codes, please contact qualified professionals for service.

When the unit is connected with the wired controller, the error code will be simultaneously shown on it.

(2). Instructions to the Error Indicating Lamps on the Panel of the Cassette Type Unit.

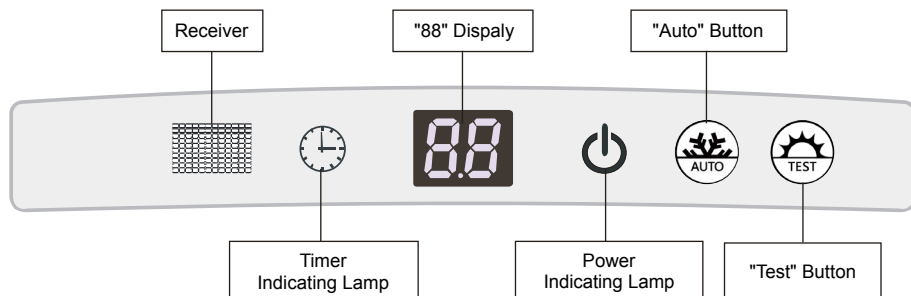

Fig.40

◆ Power and ON/OFF Indicating Lamp:

It goes red when the unit is powered on while it goes white when the unit is started.

◆ Timer Indicating Lamp:

Timer indicator on indoor unit will be on when timer ON is set under off status and timer OFF is set under on status.

◆ "88" Display:

When there is no error, the dual-8 nixie tube display the set temperature. After receiving the command of displaying indoor ambient temperature from the remote controller, the dual-8 nixie tube displays indoor temperature for 3s and then resume to display the set temperature. If there is error, error code will be displayed. If there's multiple error, error codes will be displayed in turn.

"Auto" button: It's used for turning on or turning off the unit. When use this button to turn in the unit, the unit is under auto mode.

"Test" button: It's only used for the test units. This button is only valid within 3mins after the unit is energized.

NOTE:

(1) If the light of indoor unit is turned off, when operating the remote controller to send command, the display will be on for 3s and then off.

(2) When the wired controller is connected, the indoor unit display is invalid and the unit won't receive the remote control command.

## 8 Troubleshooting and Maintenance

### 8.1 Troubleshooting

If your air-conditioning unit suffers from abnormal operation or failure, please first check the following points before repair:

Table 10

Failure	Possible Reasons
The unit cannot be started.	<ul style="list-style-type: none"> <li>① . The power supply is not connected.</li> <li>② . Electrical leakage of air-conditioning unit causes tripping of the leakage switch.</li> <li>③ . The operating keys are locked.</li> <li>④ . The control loop has failure.</li> </ul>
The unit operates for a while and then stops.	<ul style="list-style-type: none"> <li>① . There is obstacle in front of the condenser.</li> <li>② . The control loop is abnormal.</li> <li>③ . Cooling operation is selected when the outdoor ambient temperature is above 48°C.</li> </ul>
Poor cooling effect.	<ul style="list-style-type: none"> <li>① . The air filter is dirty or blocked.</li> <li>② . There is heat source or too many people inside the room.</li> <li>③ . The door or window is open.</li> <li>④ . There is obstacle at the air intake or outlet.</li> <li>⑤ . The set temperature is too high.</li> <li>⑥ . There is refrigerant leakage.</li> <li>⑦ . The performance of room temperature sensor becomes worse</li> </ul>
Poor heating effect	<ul style="list-style-type: none"> <li>① . The air filter is dirty or blocked.</li> <li>② . The door or window is not firmly closed.</li> <li>③ . The set room temperature is too low.</li> <li>④ . There is refrigerant leakage.</li> <li>⑤ . The outdoor ambient temperature is lower than -5°C.</li> <li>⑥ . Control loop is abnormal.</li> </ul>

Note: After carrying out the check of the above items and taking relevant measures to solve the problems but the air-conditioning unit still does not function well, please stop the operation of the unit immediately and contact the local service agency designated. Only ask professional serviceman to check and repair the unit.

### 8.2 Routine Maintenance

Only a qualified service person is allowed to perform maintenance.

Before accessing to terminal devices, all power supply circuits must be disconnected.



Do not use water or air of 50°C or higher for cleaning air filters and outside panels.



**Notes:**

- ① . Do not operate the air conditioner with the filter uninstalled, otherwise dust would come into the unit.
- ② . Do not remove the air filter except for cleaning. Unnecessary handling may damage the filter.
- ③ . Do not clean the unit with gasoline, benzene, thinner, polishing powder or liquid insecticide, otherwise it would cause discoloration and deformation of the unit.
- ④ . Do not wet the indoor unit in case of electric shock or fire hazard.

Increase the frequency of cleaning if the unit is installed in a room where the air is extremely contaminated.(As a yardstick for yourself, consider cleaning the filter once a half year.)

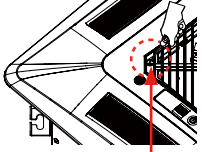
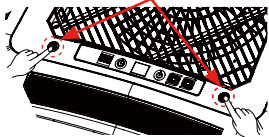
If dirt becomes impossible to clean, change the air filter.

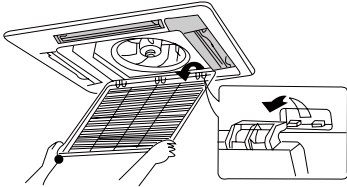
How to clean the air filter	
<p>1. Open the air inlet grille</p> <p>(1). How to open the panel grille of the 24k cassette type unit</p> <ul style="list-style-type: none"> <li>① . Push the buckle as shown in the figure.</li> <li>② . Release the screws under buckles by a screwdriver.</li> <li>③ . Push the fastener and open the panel grille.</li> </ul>	 <p style="text-align: center;">Remove the screw</p>
	 <p style="text-align: center;">Push the fastener</p>
<p>(2). How to open the panel grille of the 12/18k cassette type unit</p> <ul style="list-style-type: none"> <li>① . Remove the screws by a screwdriver as shown in the picture.</li> <li>② . Push those two fasteners and open the panel grille.</li> </ul>	 <p style="text-align: center;">Remove the screw</p>
	 <p style="text-align: center;">Push the fastener</p>

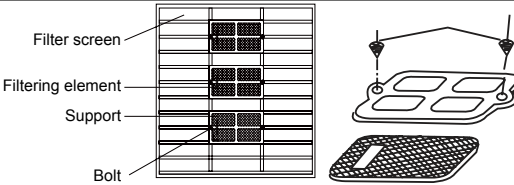
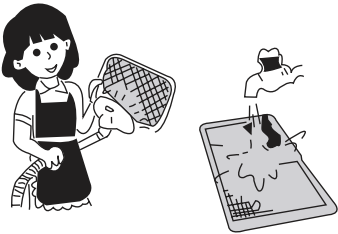
<p>2. Disassemble the air inlet grille Open the air inlet grille at 45°, raise it and remove the grille.</p>	
<p>3. Disassemble the filter screen Draw out the filter screen and remove it.</p>	
<p>4. Disassemble the air purifier Remove the air purifier after removing the fixed screws on it.</p>	
<p>5. Clean the filter screen Clean the filter screen by a vacuum cleaner or wash it by flashing water. If the oil stain on the filter can not be removed or cleaned up, wash it by warm water meld with the detergent. Dry the filter in the shadow. Note: Never use hot water over 45°C in case of color fading or turning yellow. Never dry it by fire so as to prevent the filter caught fire or deformation.</p>	
<p>6. Reset the filter</p>	<p>The same as step 3</p>
<p>7. Install the grille well</p>	<p>The same as step 1 and 2</p>



## 9 Safety operation of flammable refrigerant

### Qualification requirement for installation and maintenance man

- All the work men who are engaging in the refrigeration system should bear the valid certification awarded by the authoritative organization and the qualification for dealing with the refrigeration system recognized by this industry. If it needs other technician to maintain and repair the appliance, they should be supervised by the person who bears the qualification for using the flammable refrigerant.
- It can only be repaired by the method suggested by the equipment's manufacturer.

### Installation notes

- The air conditioner is not allowed to use in a room that has running fire (such as fire source, working coal gas ware, operating heater).
- It is not allowed to drill hole or burn the connection pipe.
- The air conditioner must be installed in a room that is larger than the minimum room area. The minimum room area is shown on the nameplate or following table a.
- Leak test is a must after installation.

table a - Minimum room area ( m<sup>2</sup> )

Minimum room area( m <sup>2</sup> )	Charge amount (kg)	≤1.2	1.3	1.4	1.5	1.6	1.7	1.8	1.9	2	2.1	2.2	2.3	2.4	2.5
	floor location	/	14.5	16.8	19.3	22	24.8	27.8	31	34.3	37.8	41.5	45.4	49.4	53.6
window mounted	/	5.2	6.1	7	7.9	8.9	10	11.2	12.4	13.6	15	16.3	17.8	19.3	
wall mounted	/	1.6	1.9	2.1	2.4	2.8	3.1	3.4	3.8	4.2	4.6	5	5.5	6	
ceiling mounted	/	1.1	1.3	1.4	1.6	1.8	2.1	2.3	2.6	2.8	3.1	3.4	3.7	4	

### Maintenance notes

- Check whether the maintenance area or the room area meet the requirement of the nameplate.
  - It's only allowed to be operated in the rooms that meet the requirement of the nameplate.
- Check whether the maintenance area is well-ventilated.
  - The continuous ventilation status should be kept during the operation process.
- Check whether there is fire source or potential fire source in the maintenance area.
  - The naked flame is prohibited in the maintenance area; and the "no smoking" warning board should be hanged.
- Check whether the appliance mark is in good condition.
  - Replace the vague or damaged warning mark.

### Welding

- If you should cut or weld the refrigerant system pipes in the process of maintaining, please follow the steps as below:

## 9 Safety operation of flammable refrigerant

- a. Shut down the unit and cut power supply
  - b. Eliminate the refrigerant
  - c. Vacuuming
  - d. Clean it with N<sub>2</sub> gas
  - e. Cutting or welding
  - f. Carry back to the service spot for welding
- The refrigerant should be recycled into the specialized storage tank.
  - Make sure that there isn't any naked flame near the outlet of the vacuum pump and it's well-ventilated.

### **Filling the refrigerant**

- Use the refrigerant filling appliances specialized for R32. Make sure that different kinds of refrigerant won't contaminate with each other.
- The refrigerant tank should be kept upright at the time of filling refrigerant.
- Stick the label on the system after filling is finished (or haven't finished).
- Don't overfilling.
- After filling is finished, please do the leakage detection before test running; another time of leak detection should be done when it's removed.

### **Safety instructions for transportation and storage**

- Please use the flammable gas detector to check before unload and open the container.
- No fire source and smoking.
- According to the local rules and laws.

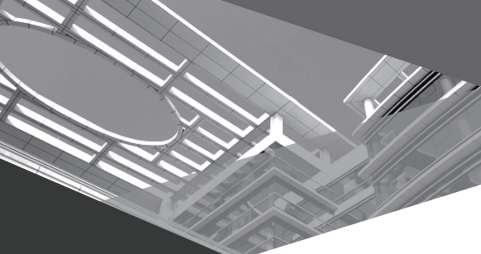

**GREE ELECTRIC APPLIANCES, INC. OF ZHUHAI**

Add: West Jinji Rd, Qianshan, Zhuhai, Guangdong, China, 519070

Tel: (+86-756) 8522218

Fax: (+86-756) 8669426

E-mail: [gree@gree.com.cn](mailto:gree@gree.com.cn) [www.gree.com](http://www.gree.com)



600005060037