



GMV5 COMPACT MULTI VRF UNIT SERVICE MANUAL

R410A/50/60Hz

CONTENTS

PRODUCT.....	2
1 PRODUCT LIST	2
2 PRODUCT FEATURES.....	2
3 SPECIFICATIONS.....	4
4 PRODUCT CAPACITY CORRECTION	5
5 PRINCIPLE OF OPERATION.....	7
CONTROL.....	10
1 UNITS CONTROL	10
2 WIRED CONTROLLER	18
3 REMOTE CONTROLLER	44
INSTALLATION	49
1 TOOLS AND EQUIPMENT FOR INSTALLATION AND MAINTENANCE	49
2 INSTALLATION KEY POINTS AND IMPORTANCE.....	51
3 INSTALLATION MATERIALS SELECTION.....	53
4 INSTALLATION OF OUTDOOR UNIT	56
5 INSTALLATION OF INDOOR UNIT	60
6 EXCURSUS.....	70
MAINTENANCE.....	73
1 TROUBLE TABLE.....	73
2 FLOW CHART OF TROUBLE SHOOTING	77
3 POWER DISTRIBUTION	92
4 DISASSEMBLY AND ASSEMBLY PROCEDURE OF MAIN PARTS	96
5 COMMON MAINTENANCE	112
6 EXPLODED VIEW OF UNIT AND PARTS LIST	117

PRODUCT

PRODUCT

1 PRODUCT LIST

1.1 Outdoor unit

Model	Product Code	Cooling Capacity(kW)	Heating Capacity(kW)	Refrigerant	Appearance
GMV-224WL/A-X	CN850W0200	22.4	25	R410A	
GMV-250WL/A-X	CN850W0210	25	28		
GMV-280WL/A-X	CN850W0190	28	30		

2 PRODUCT FEATURES

GREE GMV5 Compact series All DC Inverter VRF outdoor units (R410A) are based on GREE DC Inverter compressor technology and special designed for the residential apartments, commercial offices and super markets. And the capacity range of GMV5 Compact series outdoor units is 22.4 kW, 25 kW and 28 kW.

◆ DC Inverter technology

Selects the superior high-pressure chamber two-spod compressor, independent research and development new generation “G-MATRIK” perfect DC inverter drive technology, special custom dual-core DSP chip, single chip and

dual-frequency intergrated drive technology, and parallel processing ability increase 100%. By using G-MATRIK technology, the harmonic wave of drive current is less, the torque ripple is small, and the efficiency is high and vibration noise is low. Adopts independent R&D high frequency and weak magnetic technology to make the inverter compressor run in wide frequency of 15~120Hz and wided voltage of 240~450V and it has good speed regulation performance, wide speed range and is more comfortable.

◆ **The bionic super-quiet fan blade**

Adopting aerodynamics and the theory of bionics research achivements, the unique pits on the leading edge of the blade effectively destroy the formation of the leading edge vortex and prevent it from falling off. The pits and the separation vertex on the leading edge are broken into small ones, which reduces 2dB of broadband noise and improves sound quality. At the same time it reduces the load of the fan motor, which makes the fan run more efficiently.

◆ **New generation CAN bus communication**

Due to the latest communication method—CAN Bus Communication, system's anti-interference capability is stronger and the control on indoor units is more accurate, with higher reliability. When a single indoor unit or outdoor unit quit the communication automatically, there is no impact on the network. Multiple means of communication, sataus information of the units in the network can be feed back immediately. The use rate of CAN bus is improved 10 times of 485 communication. The communication between indoor and outdoor unit is up to 20Kbps, which has increased by 100% and date exchange is faster. Multi-group network, it is easy to extend to the new device (any equipment conforms to CAN protocol) and realize the non-polarity installation. The communication distance is up to 1500 m.

◆ **New oil return technology**

Gree active balancing oil return technology provides a new method for controlling the oil level of parallel compressor, which makes the oil level automatically adjust near the hole for balancing oil when the compressor is runnig to prevent the compressor from running in short of oil for long time and avoid the damage. At the same time it can avoid oil hammer for the oil level is too high.

◆ **Long distance refrigerant pipe**

The longest piping length is up to 100 m, the longest equivalent length is up to 125 m. The drop between indoor units is up to 15 m. When the outdoor unit is above the indoor unit, the biggest drop is up to 50 m. When the outdoor unit is under the indoor unit, the drop is up to 40 m.

◆ **Free design and easy installaiton**

With four-way airflow design, humanized base, simple piping and wiring system, sideward airflow design,the installation of the unit can be against the wall and more easy and convenience, which greatly reduce the cost of transporation and installation.

◆ **Perfect malfunction protection**

The function for malfunction protection is perfect, which includes over current protection, high pressure protection, low pressure protection, exhaust temperature protection, phase lacking protection, voltage protection, communication malfunction, temperature sensor malfunction to ensure the reliable operation for the unit.

◆ **Abundant indoor units**

One outdoor unit of GMV5 Compact multi VRF matches different kinds and different capacity of indoor units. According to the use and decoration features of the room, the types of units can be chose includes high static pressure duct, super slim duct, four-way cassette, one-way cassette, wall-mounted and so on. The units can be widely used in different size and different uses of the modern household, commercial offices as well as upscale villas, apartments, penthouse and so on.

3 SPECIFICATIONS

3.1 Specifications

Model		GMV-224WL/A-X	GMV-250WL/A-X	GMV-280WL/A-X
Product Code		CN850W0200	CN850W0210	CN850W0190
Cooling Capacity	KW	22.4	25	28
Heating Capacity	KW	25	28	30
Air Flow Volume	m ³ /h	9000	9000	9000
Sound Pressure Level	dB(A)	60	61	61
R410A Filling Amount	kg	7.2	7.6	7.6
EER	W/W	3.34	3.38	3.37
COP	W/W	3.82	3.81	3.68
Phases	-	3	3	3
Rated Voltage	V	380V	380V	380V
Rated Frequency	Hz	50/60	50/60	50/60
Cooling Power Input	kW	6.70	7.40	8.30
Heating Power Input	kW	6.54	7.35	8.15
Rated Power Input	kW	8.50	11.30	12.10
Dimensions of Unit (mm) (Width×Depth×Height)		1098×399×1584	1098×399×1584	1098×399×1584
Dimensions of Package (mm) (Width×Depth×Height)		1183×505×1785	1183×505×1785	1183×505×1785
Compressor		QXAS-D32zX050 ×2	QXAS-F428zX050B ×2	QXAS-F428zX050B ×2
Moisture Protection		IPX4	IPX4	IPX4

Connecting pipe	Gas Pipe	mm	22	22	22
	Liquid Pipe	mm	9.52	9.52	9.52
	Connection Method		Brazing Connection	Brazing Connection	Brazing Connection
Net Weight		kg	175	185	185

Note:

① The technical parameters are changed along with the products' improvement; please refer to the nameplate of the unit for actual data.

② Noise is tested in the semi-anechoic room, so it should be slightly higher in the actual operation due to environmental change.

③ Rated conditions:

Cooling: Indoor air temperature 27°C (81°F) DB / 19°C (66.6°F) WB

Outdoor air temperature 35°C (95.4°F) DB / 24°C (75.6°F) WB

Heating: Indoor air temperature 20°C (68°F) DB / 15°C (59°F) WB

Outdoor air temperature 7°C (44.6°F) DB / 6°C (42.8°F) WB

3.2 Operating range

Cooling Operation	Outdoor Ambient Temperature: 10°C ~ 52°C
Heating Operation	Outdoor Ambient Temperature: -20°C ~ 27°C

4 PRODUCT CAPACITY CORRECTION

4.1 Correction factor of indoor and outdoor temperature

a. Correction factor of cooling capacity

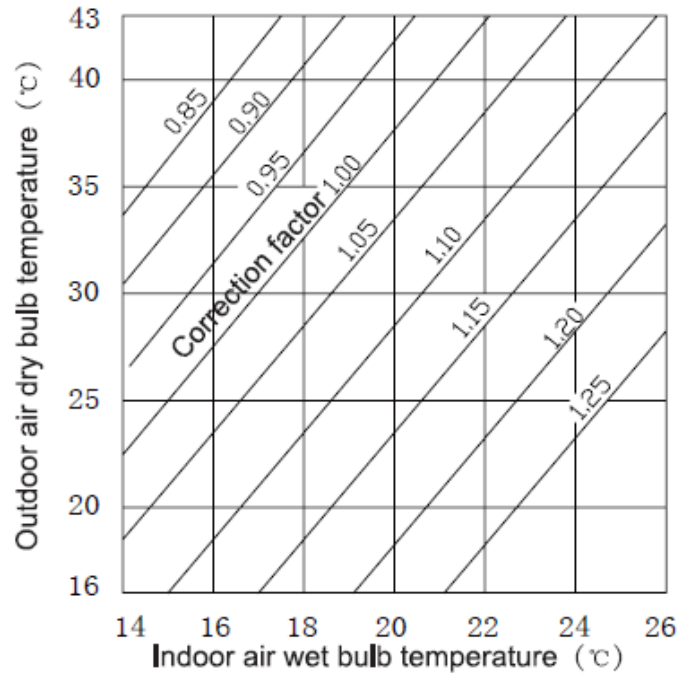

b. Correction factor of heating capacity

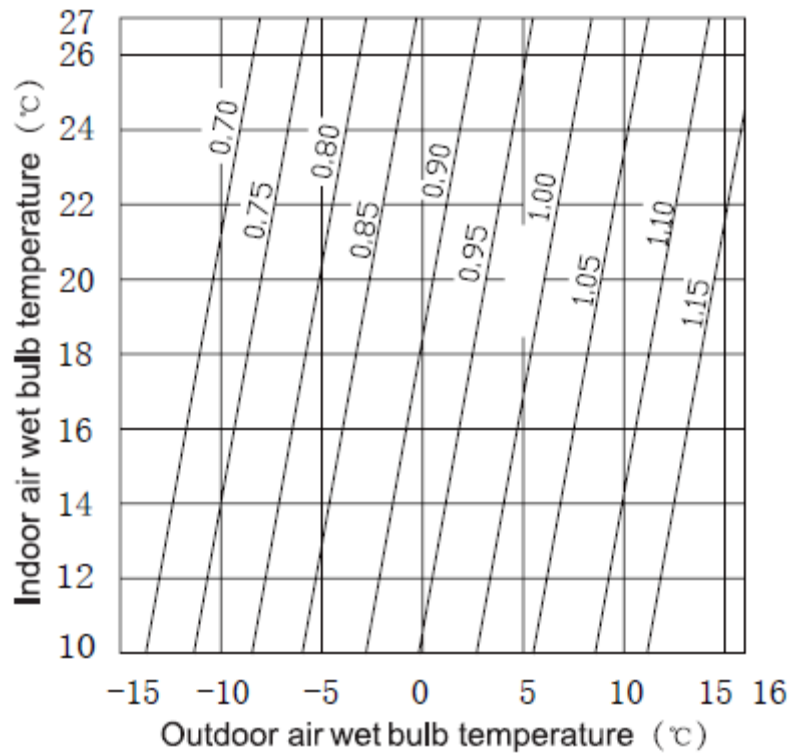

4.2 Correction factor of pipe length and height difference

(1) Symbol description:

Hp: Height difference in case indoor unit is below outdoor unit (m);

Hm: Height difference in case indoor unit is above outdoor unit (m);

L: Length of one-way equivalent pipe.

(2) Below table shows the capacity variance ratio for 100% full load in standard working condition (thermostat

setting is 16°C for cooling and 30°C for heating).

a. Variance ratio of cooling capacity

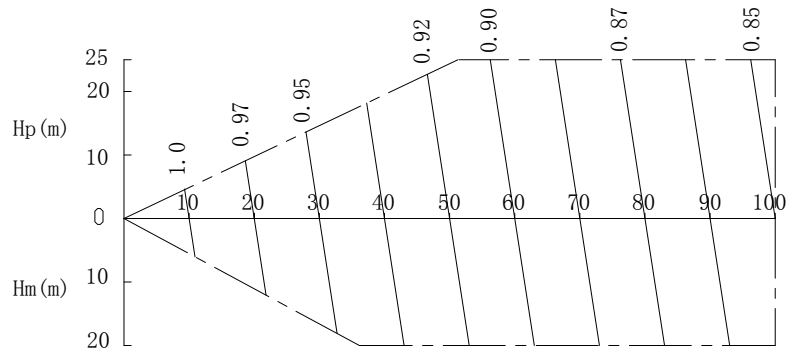

b Variance ratio of heating capacity

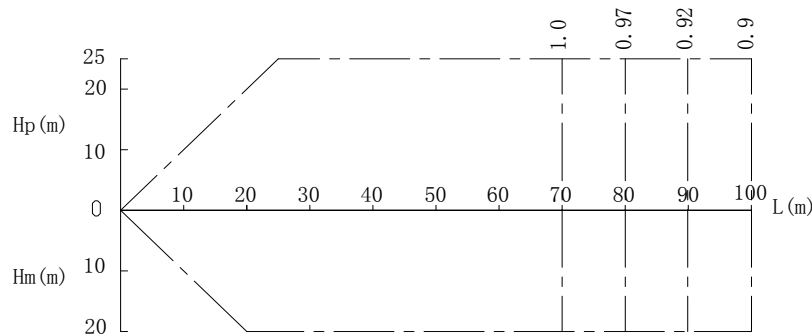

Under heating operation, it may frost when there is snow on the outdoor heat exchangers or the outdoor temperature is below 6°C, which will reduce the heating capability of the unit.

5 PRINCIPLE OF OPERATION

5.1 System Flowchart

As the following system flowchart, principle of operation is:

Connecting to power supply, the unit starts to work. In cooling, the low-temperature and low-pressure refrigerant gas from each indoor heat exchanger will be merged and inhaled by the compressor and then become high-temperature and high-pressure gas, which will later be discharged into outdoor heat exchangers. By exchanging heat with outdoor air, refrigerant will turn to liquid and flow to each indoor unit via Y-type branch or manifold. Pressure and temperature of the refrigerant will then be lowered by throttle elements before it flows into indoor heat exchangers. After exchanging heat with indoor air, refrigerant will become low-temperature and low-pressure gas again and repeat the circulation so as to realize the cooling effect. In heating, 4-way valve will be energized to make refrigerant circulate in a reverse direction of cooling. Refrigerant will release heat in indoor heat exchangers (electric heating elements will also work under certain circumstance and release heat) and absorb heat in outdoor heat exchangers circularly so as to realize the heating effect.

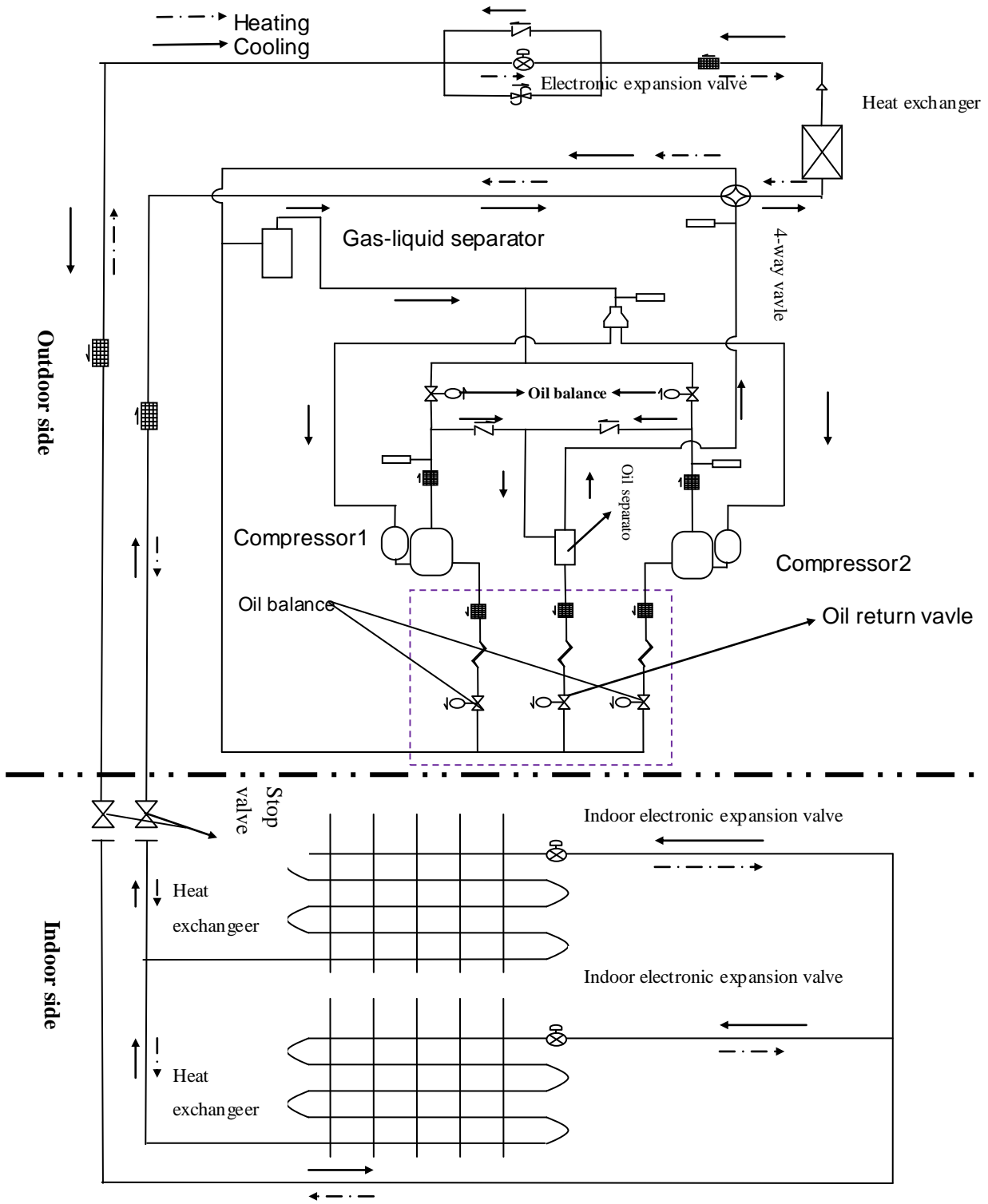

CONTROL



CONTROL

1 UNITS CONTROL

1.1 Mentality of Units' control

1.1.1 Schematic diagram of units' control

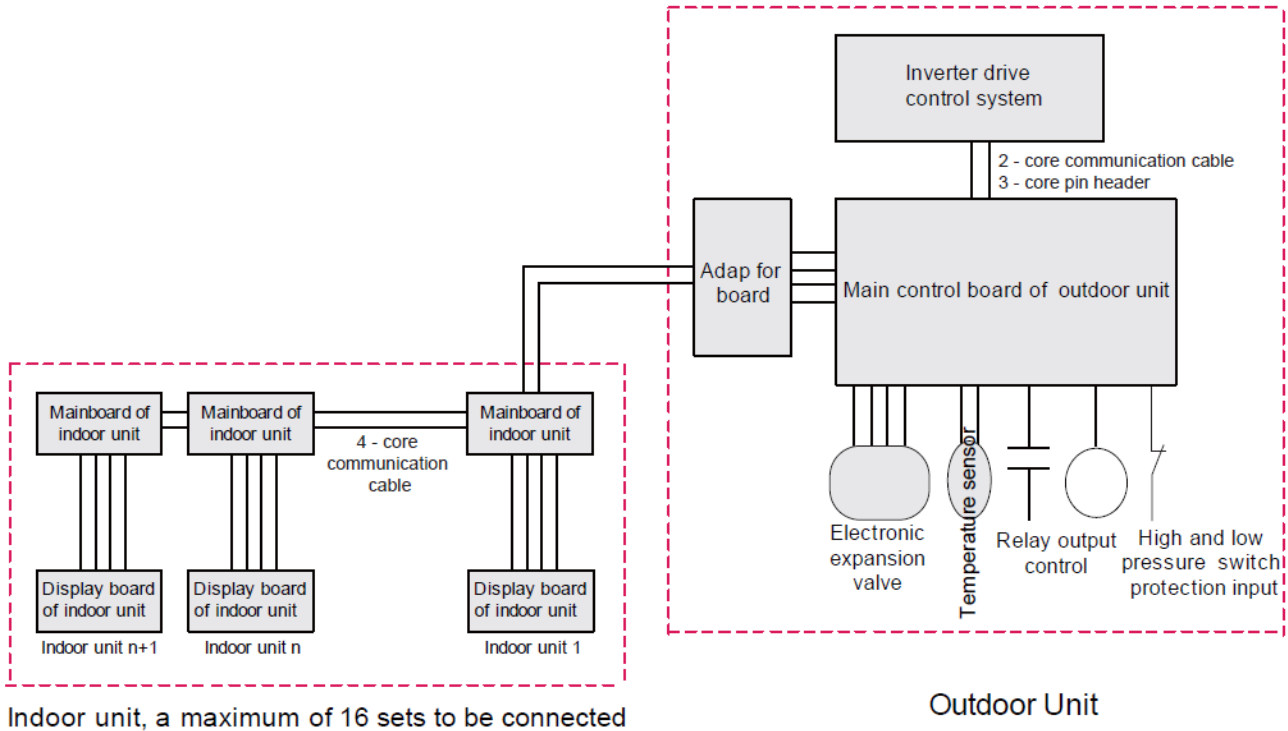

Air conditioning units can be divided into indoor unit and outdoor unit. A maximum of 16 sets of indoor units can be connected to an outdoor unit. 2-core (3-core pin header) communication cable is used for the connection between indoor unit and outdoor unit. Indoor unit is connected to display board via 4-core communication cable. In engineering installation, address dial-up of the display board and the mainboard of indoor unit shall be dialed. The address dial-up of the mainboard of indoor unit must be identical with that of the display board of the same indoor unit. Address dial-up of different indoor unit must vary. Multi VRF indoor unit is applicable to all digital or inverter outdoor units.

Controller of outdoor unit falls into two categories in terms of its function, i.e. main control system and inverter drive control system

1.1.2 Interpretation on the schematic diagram

(1) Main control system

A. Functions: main control system shall be connected to indoor unit through 2-core (3-core pin header) communication cable in order to receive start or stop commands, mode, setting temperature and ambient temperature from indoor unit, determine operation mode of outdoor unit, and through calculation based on capacity, decide proper running frequency which shall be sent to the drive control system through 2-core (3-core pin header) communication cable. Fan speed shall be regulated according to system pressure. Real-time monitoring of

temperature sensors, operation state and protection of unit shall be performed to ensure normal and stable operation of the whole system. Protection codes of outdoor unit shall be displayed on the LED on the main control board when failure occurs. When drive is at fault, E5 shall be displayed on the display board of indoor unit, and specific failure type shall be indicated on the LED on the main control board of outdoor unit.

B. Input and output controlled variables

Sensors include ambient temp. sensor, tube-inlet temp. sensor, tube-middle temp. sensor, tube-outlet temp. sensor, compressor exhaust temp. sensor, compressor casing top temp. sensor, high pressure sensor and low pressure sensor.

Switch protection: high pressure protection, over-current protection

Output control objects: fan frequency, compressor heat tape (controlled by drive board), compressor AC contactor (3-phase, controlled by drive board), gas bypass valve, 4-way valve, solenoid valve A, oil equilibrium valve, liquid bypass valve and capillary solenoid valve.

C. 485 communication interface: indoor unit communication network and adaptor board CN1 shall be connected to the mainboard of indoor unit through 2-core (3-core pin header) communication cable; drive communication network and the mainboards CN11~CN14 of outdoor unit shall be connected to the drive board through 2-core (3-core pin header) communication cable.

(2) Drive control system

Three-phase power unit:

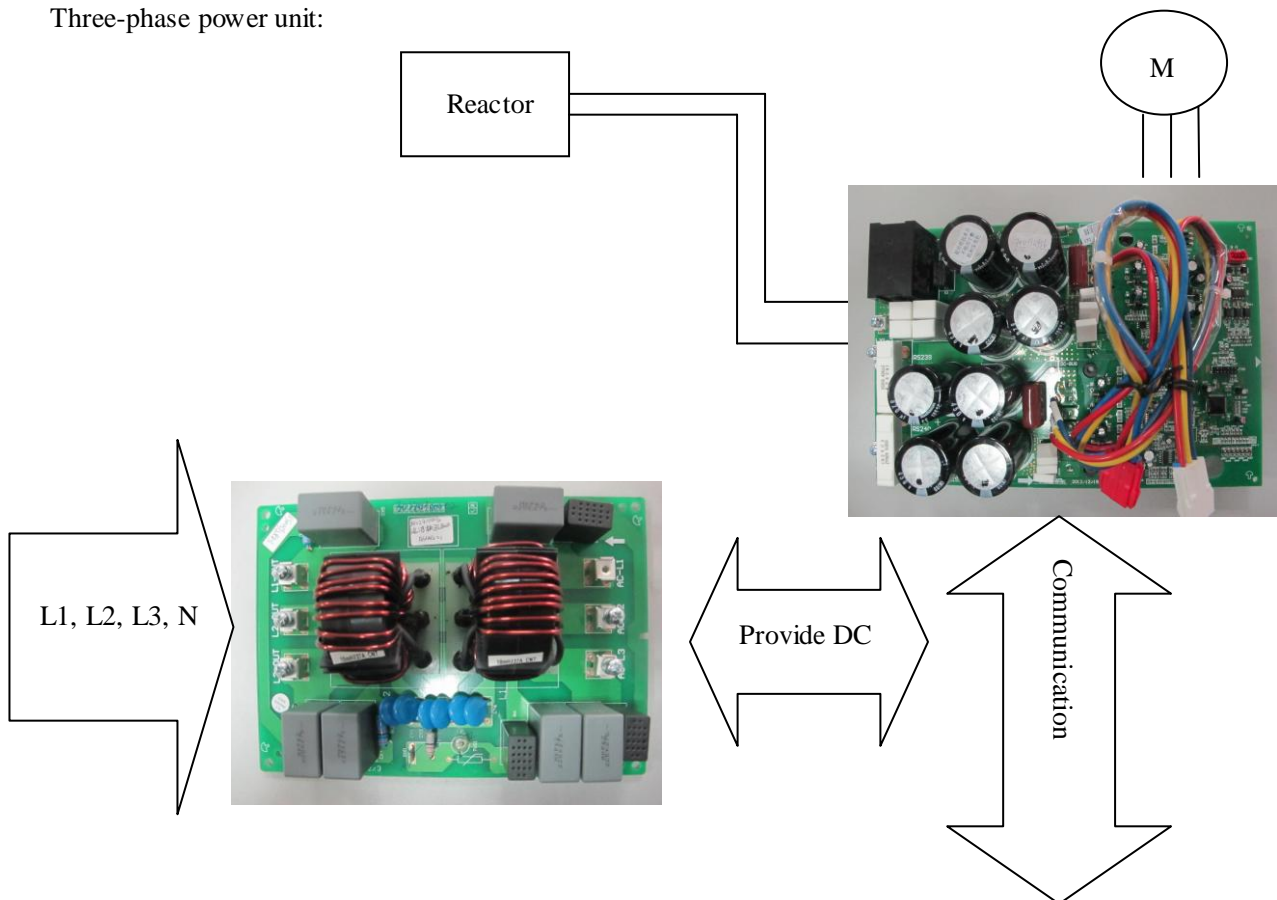

Functions of various modules:

A Filter plate: one of the two key functions is to filter and eliminate power interferences and ensure anti-interference capability of the unit even in a rugged power supply environment; the other one is to suppress interferences from power supply in order to prevent the operation of the unit from affecting other appliances such as TV. Because inverter unit works in a special way that is relatively sensitive to interferences, filter plate is normally arranged. Because 3-phase power supply is used for the unit, 3-phase filter plate that uses 3-stage filtering mode shall be employed. Input terminals of 3-phase filter plate are respectively AC-L1, AC-L2, AC-L3 and N, and corresponding output terminals are respectively L1-OUT, L2-OUT, L3-OUT and N-OUT.

B Drive board is a key part of control system. Receiving commands from the main control board, the drive board can transform 380V, 50Hz, 3-phase commercial power into AC power with adjustable amplitude and frequency, capable to drive compressor.

1.2 Operation Flowchart of the unit

1.2.1 Operation Flowchart of the Indoor Unit

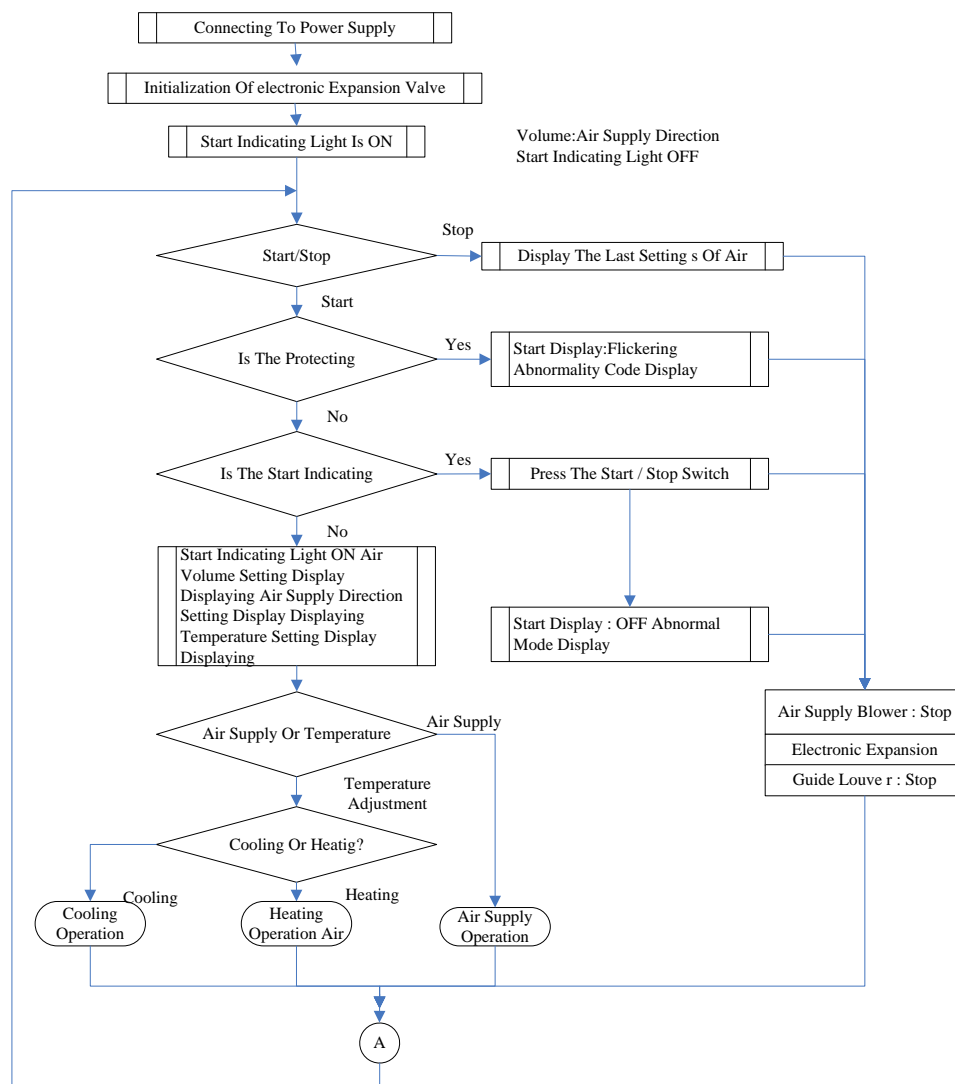

◆ Cooling Operation

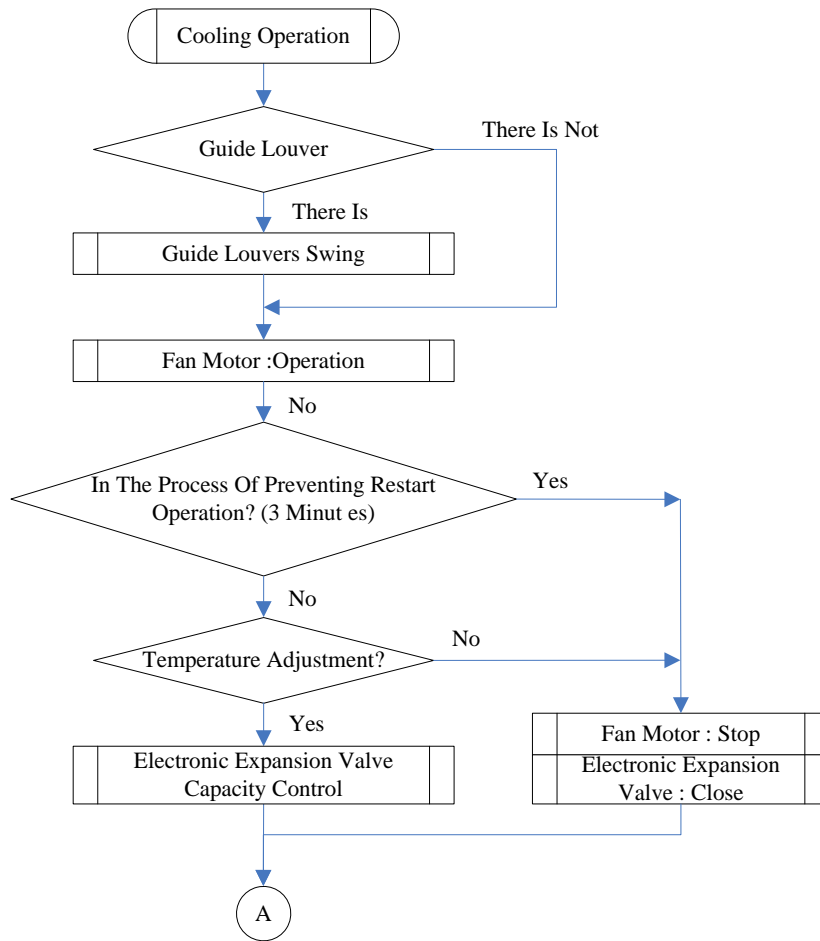

◆ Air Supply Operation

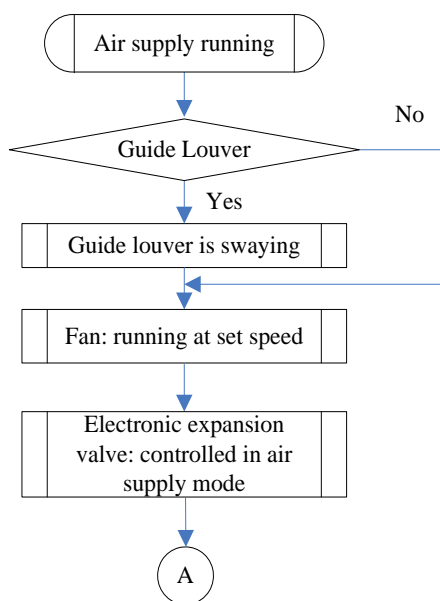

◆ Heating Operation

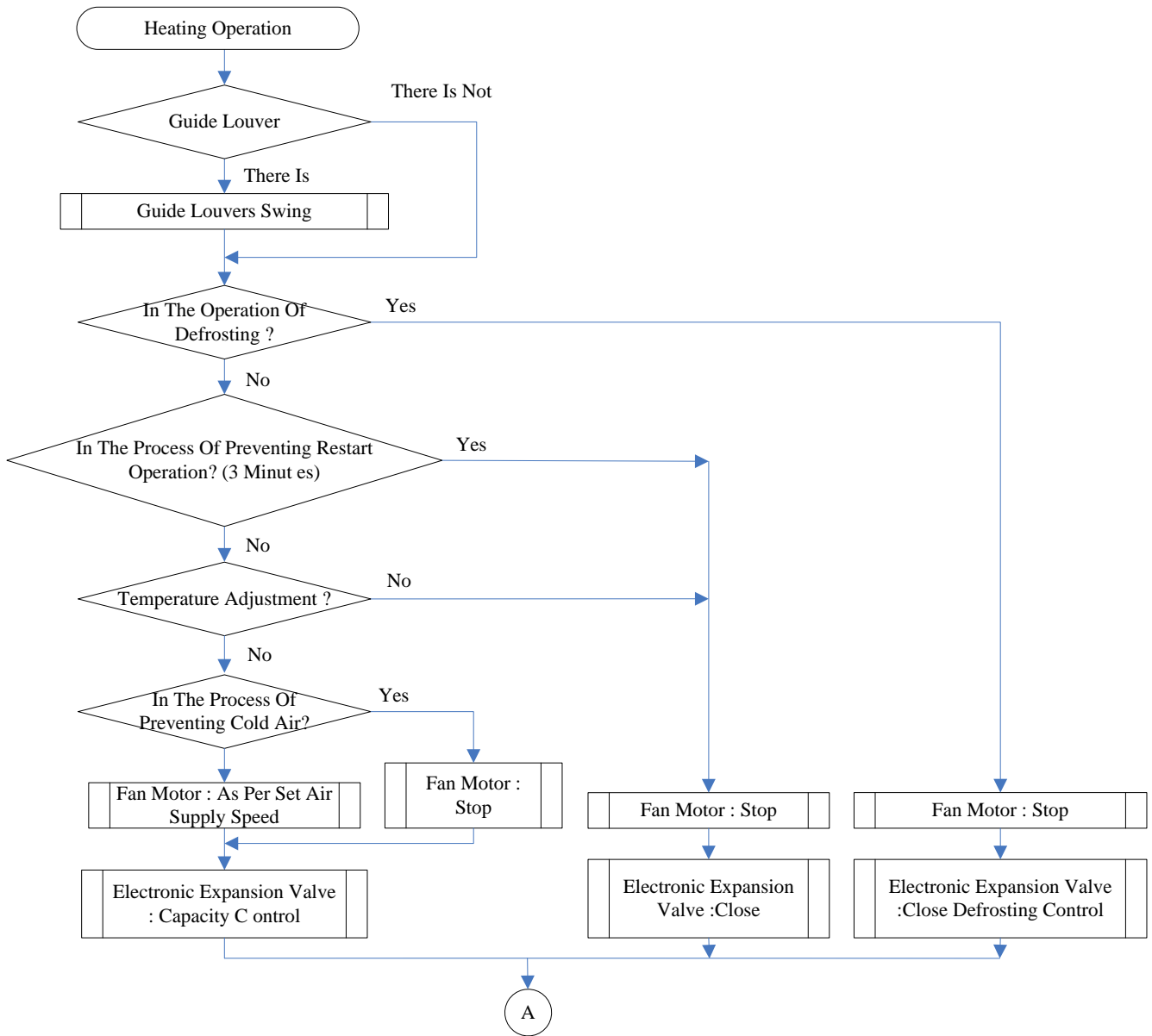

◆ Dry Operation

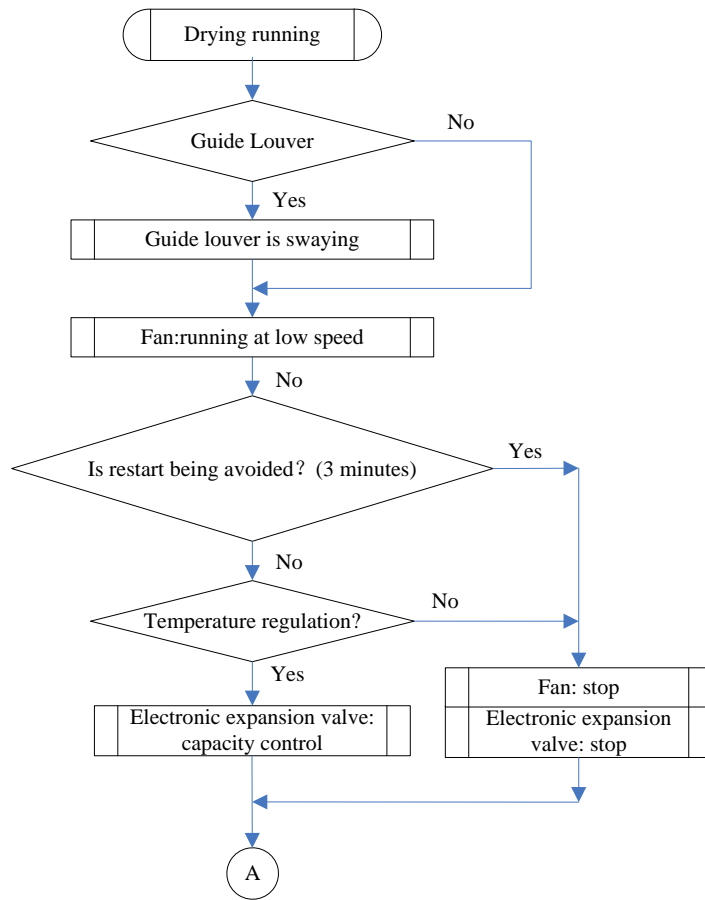

◆ Cooling Operation

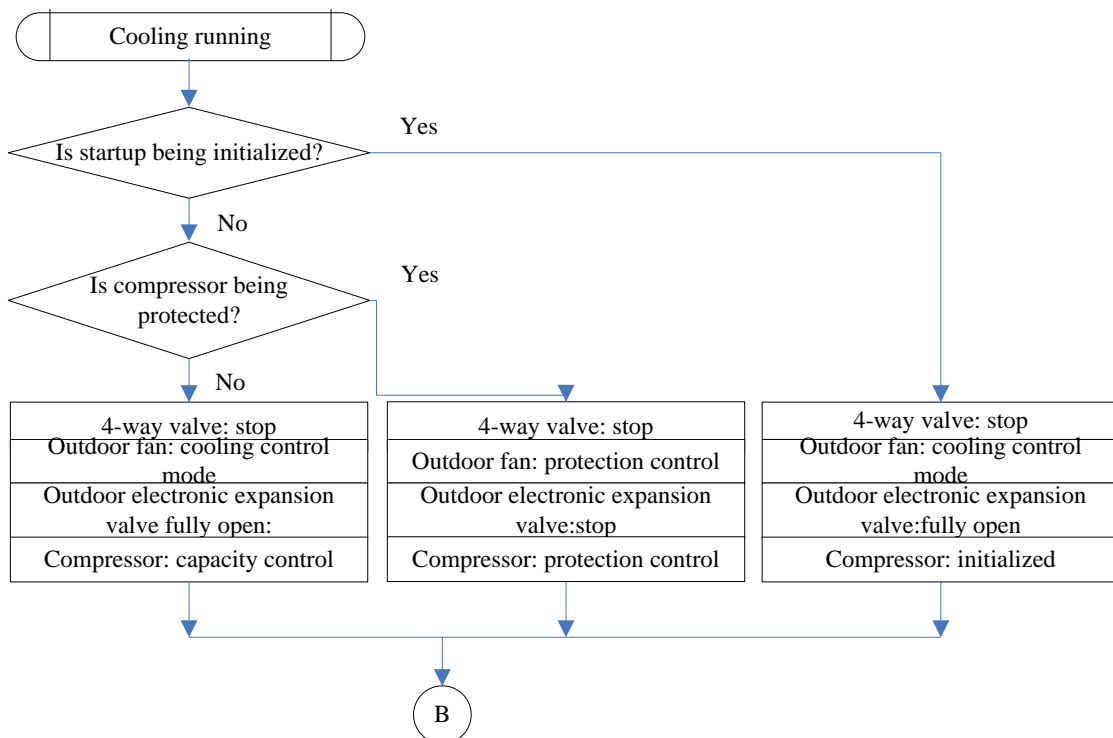

1.2.2 Operation Flowchart of the Outdoor Unit

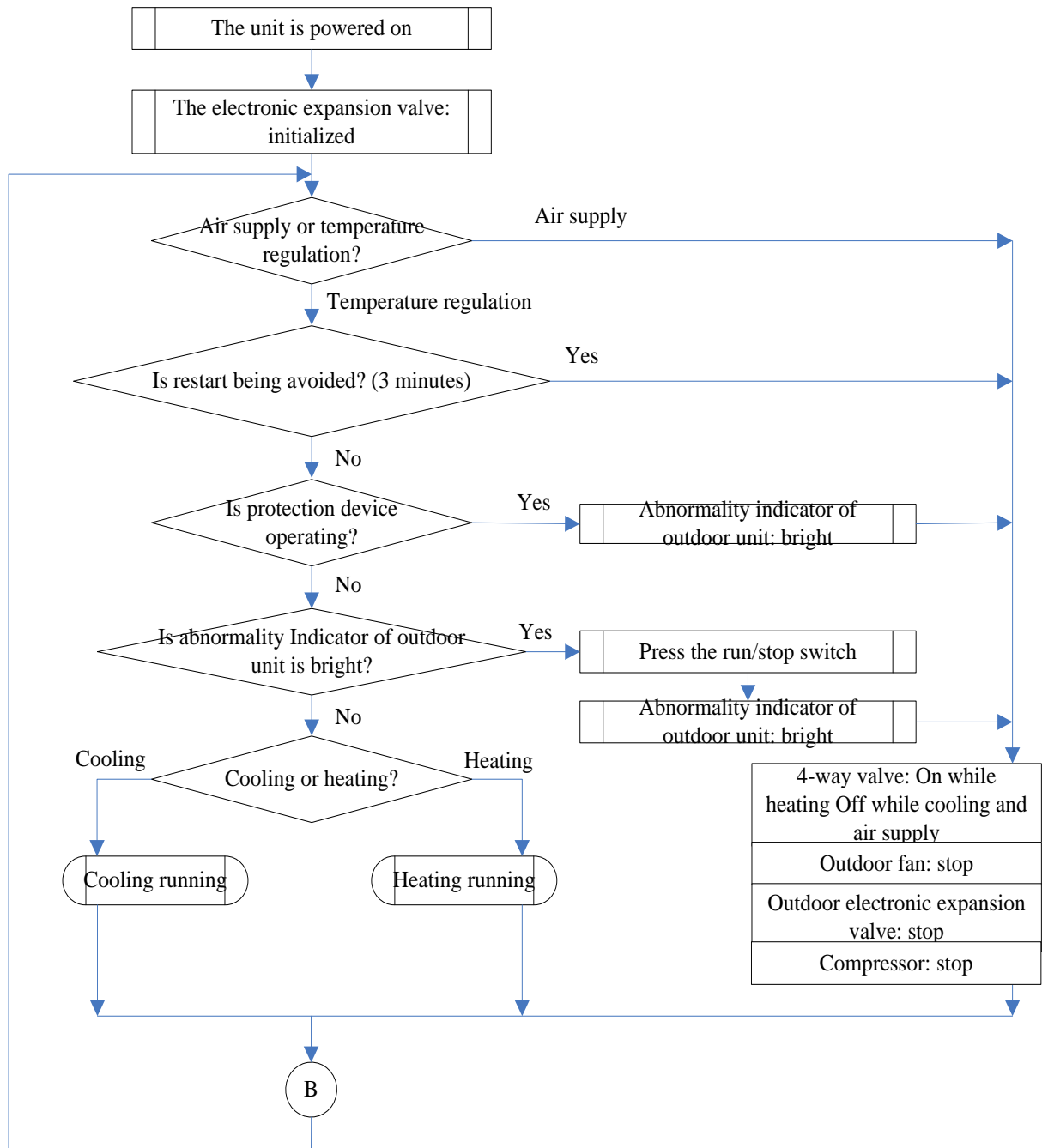

◆ Heating Operation

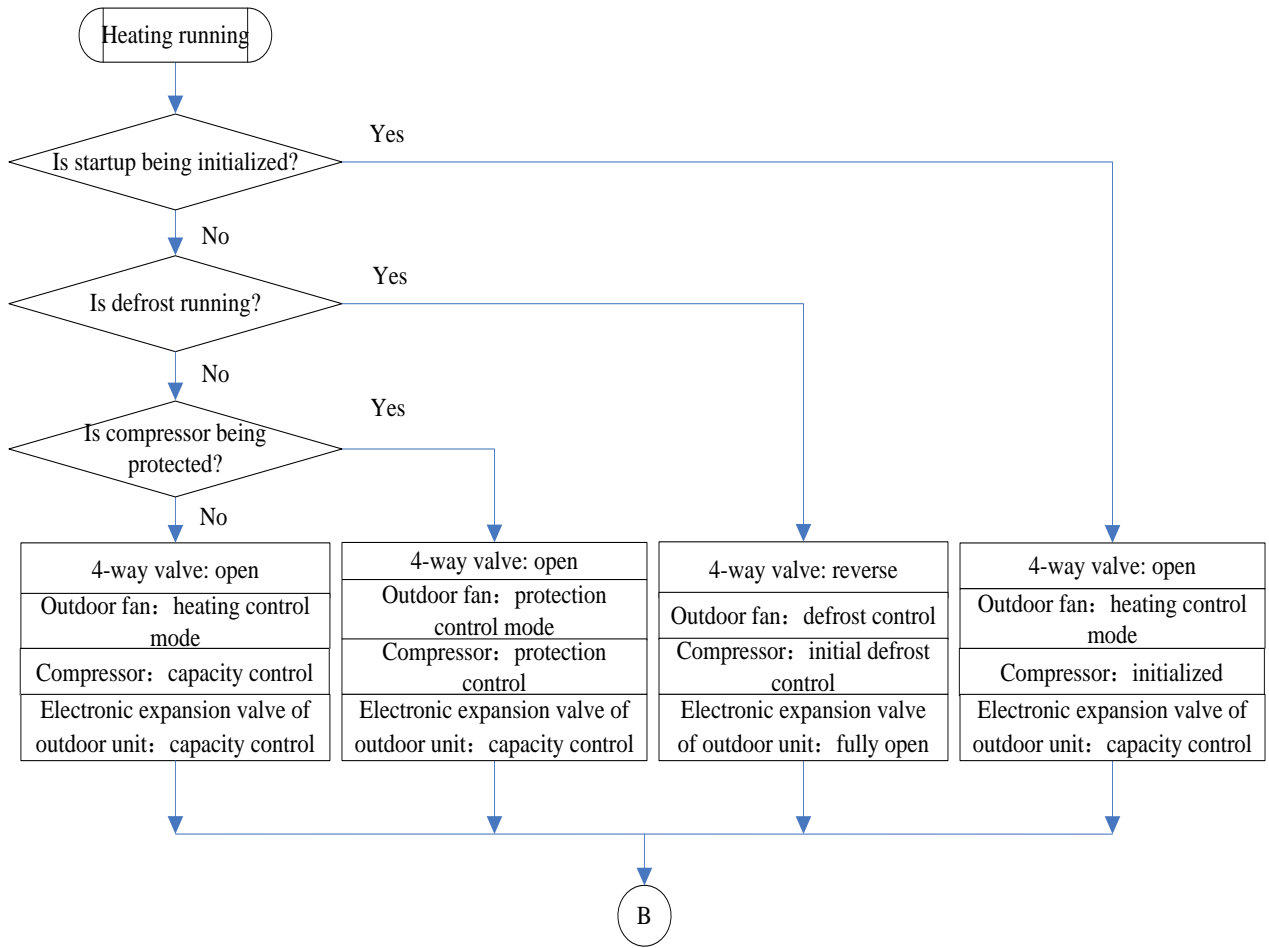





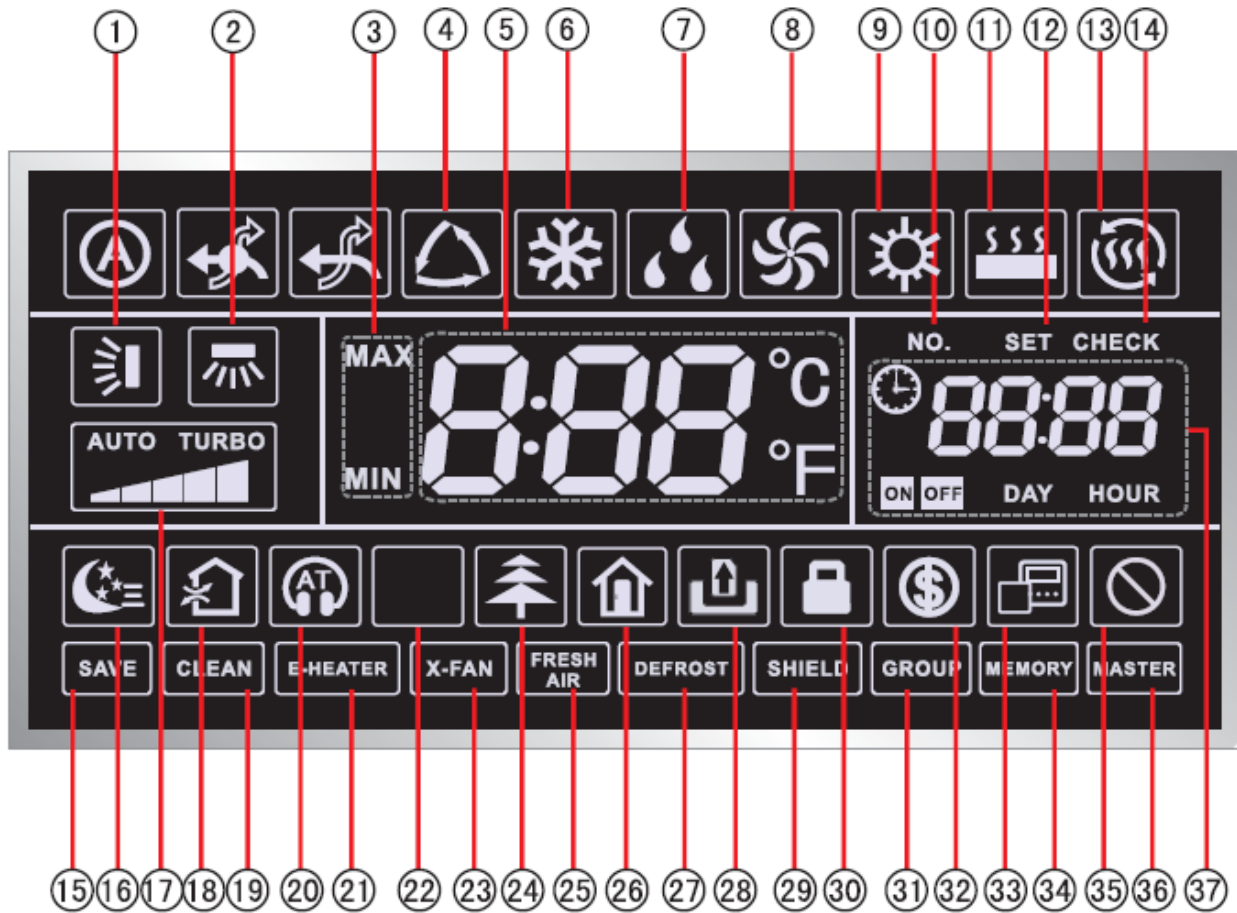































2 WIRED CONTROLLER

2.1 Control panel



1) LCD Display Instruction

NO.	Symbols	Instructions
1		Up and down swing function
2		Left and right swing function
3		It's valid under Save mode and displays during setting process. Temperature lower limit for Cooling: Limit the minimum temperature value under Cooling or Dry mode. Temperature upper limit for Heating: Limit the maximum temperature value under Heating, Space Heating or 3D Heating mode.
4		Auto mode (Under Auto mode, the indoor units will automatically select their operating mode as per the temperature change so as to make the ambient comfortable.)
5		It shows the setting temperature value (In case the wired controller is controlling a Fresh Air Indoor Unit, then the temperature zone will display FAP)
6		Cooling mode
7		Dry mode.
8		Fan mode
9		Heat mode
10		When inquiring or setting project number of indoor unit, it displays "NO." icon
11		Floor Heating mode (When Heating and Floor Heating simultaneously shows up, it indicates 3D Heating is activated.)
12		Display "SET" icon under parameter setting interface
13		Space Heating mode
14		Display "CHECK" icon under parameter view interface
15		Outdoor unit operates under Save mode/upper limit of system capacitor less 100%/remote Save status
16		Sleep status
17		Current set fan speed (including auto, low speed, medium-low speed, medium speed, medium-high speed, high speed and turbo seven status)
18		Air status

19		Remind to clean the filter
20		Quiet status (including Quiet and Auto Quiet two status)
21		Allow auxiliary electric heating On icon
22		Light On/Off function
23		X-fan function
24		Health function
25		Fresh air status
26		Out function
27		Outdoor unit defrosting status
28		Gate-control function
29		Shielding status
30		Child Lock status
31		One wired controller controls multiple indoor units
32		Save status of indoor unit
33		It indicates the current wired controller is the slave wired controller (address of wired controller is 02)
34		Memory status (The indoor unit resumes the original setting state after power failure and then power recovery)
35		Invalid operation
36		Current wired controller connects master indoor unit
37		Timer zone:Display system clock and timer status
Note: When wired controller is connected with different indoor units, some functions will be different		

2) Button Graphics

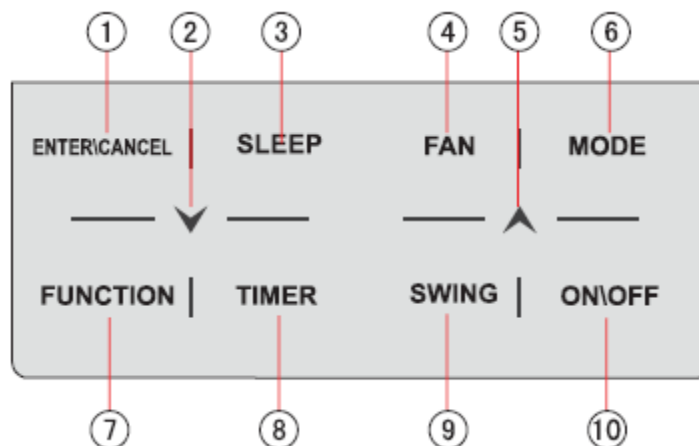

Instruction to functions of buttons

No.	Name	Function
1	Enter/Cancel	Select and cancel function
2	▼	(1) Set operating temperature of indoor unit (2) Set Timer
5	▲	(3) Switch Quiet mode, Air grade, Clean grade, set upper and lower temperature limit under Save mode (4) Set and inquiry parameter
3	Sleep	Set sleep mode
4	Fan	Switch among auto, low speed, low-medium speed, medium speed, medium-high speed, high speed and turbo status
6	Mode	Switch Auto, Cooling, Dry, Fan, Heating, Floor Heating, 3D Heating and Space Heating modes for indoor unit. (Note: The Floor Heating, 3D Heating and Space Heating function icon will show up when the unit has those functions.)
7	Function	Switch among Air, Quiet, Light, Health, Out, Save, Clean, E-heater and X-fan functions
8	Timer	Timer setting
9	Swing	Set up and down swing status
10	On/Off	Indoor unit On/Off
2+5	▲+▼	Simultaneously press “ ” and “ ” for 5s to enter or cancel the Child Lock function

2.2 Installation and removal of wired controller

2.2.1 Installation dimensions

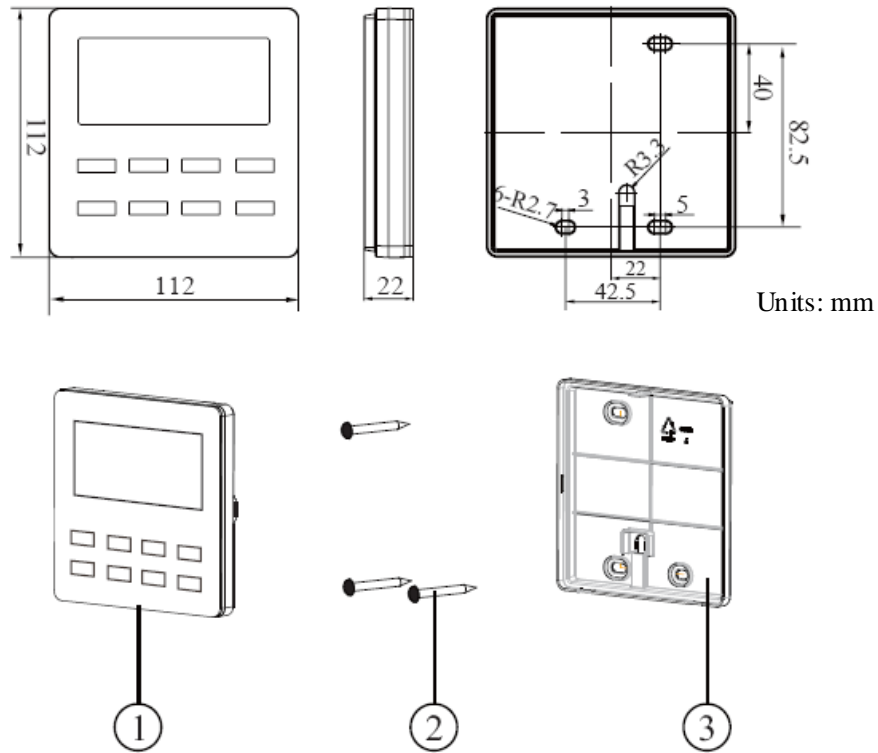

Units: mm

No	1	2	3
Name	Panel of Wired Controller	Screw M4X25	Base plate of Wired Controller
Quantity	1	3	1

◆ Selection requirement of Communication wire

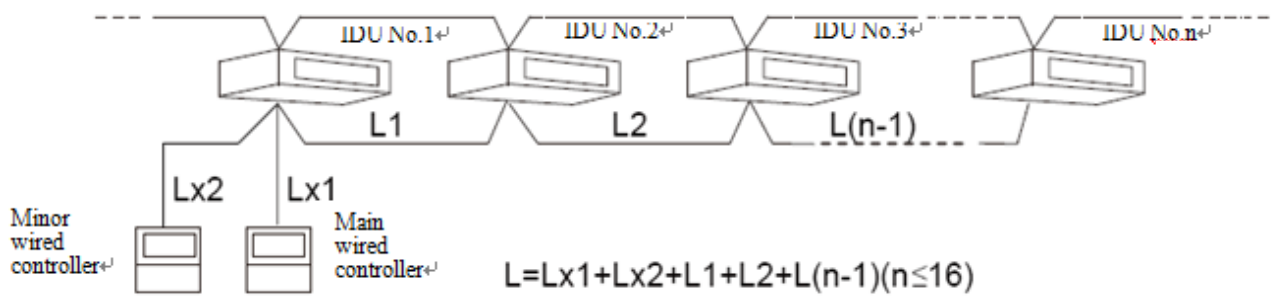

Material	Standard	Sectional area d(mm ²)	Length L(m)	Remarks
RVV	GB/T 5023.5-2008	0.5 ≤ d < 0.75	L ≤ 170	Recommended you using the communication wire that dia is 0.75mm ²
		0.75 ≤ d ≤ 1.0	L ≤ 250	

Note:

- ① If the units were placed at a place with stronger electromagnetism, the communication wire between indoor unit and wire controller should use screen wire for shielding the electromagnetism, and the communication wire between indoor unit and outdoor (or indoor) unit should use STP for shielding the electromagnetism.
- ② Choose the material of communication according to the instruction .It is banned for selecting the wire that is not satisfy the requirement of the instruction.

▼ Installation Requirement

- (1). Prohibit installing the wired controller at the humid place or the place with direct sunlight.
- (2). Prohibit installing the wired controller at the the place with direct sunlight.
- (3). Prohibit installing the wired controller at the place near high temperature objects or water-splashing places.
- (4). Prohibit installing the wired controller at the place where faces forward to the window, to avoid interference of another remote controller from neighborhood

◆ Connection requirement

There are 4 ways to connect wired controller with indoor units' network:

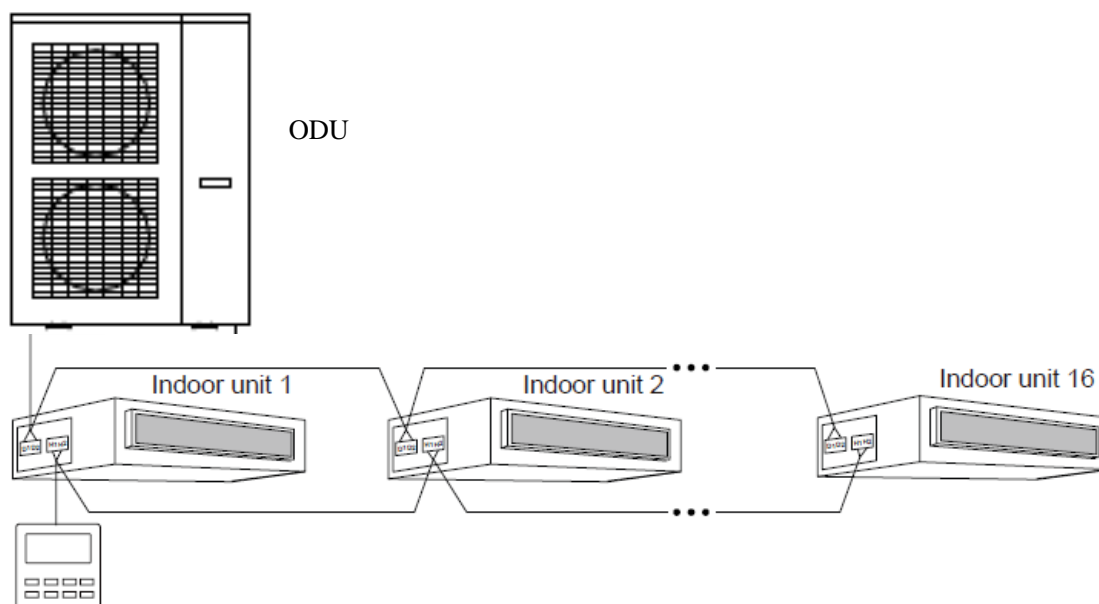

Fig.1 One wired controller controls multiple indoor units simultaneously

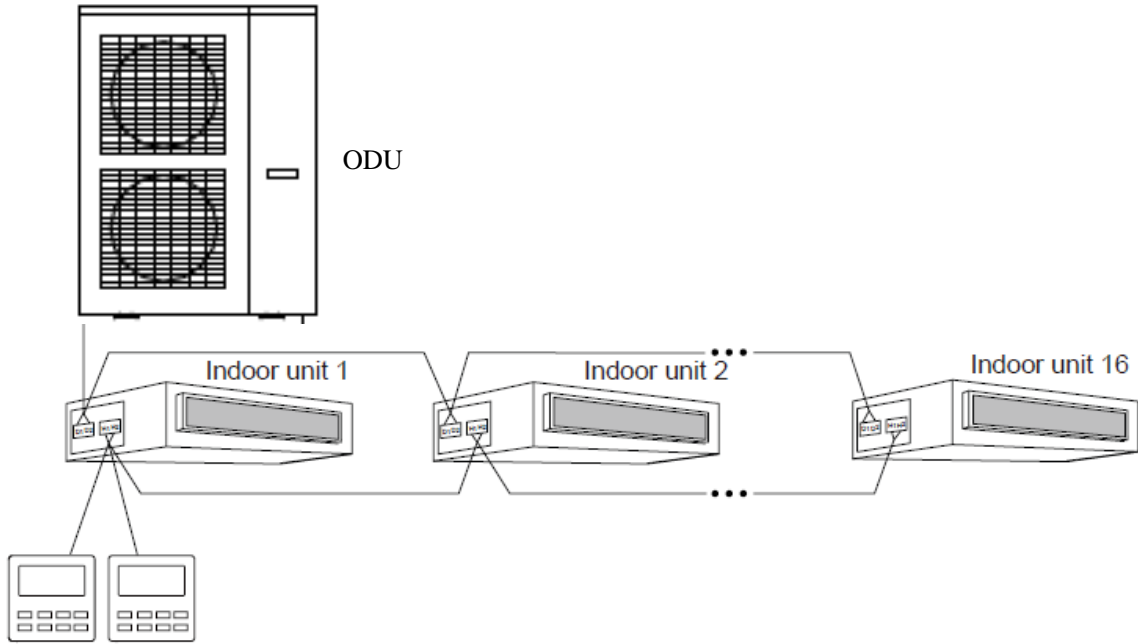

Fig.2 Two wired controllers control multiple indoor units simultaneously

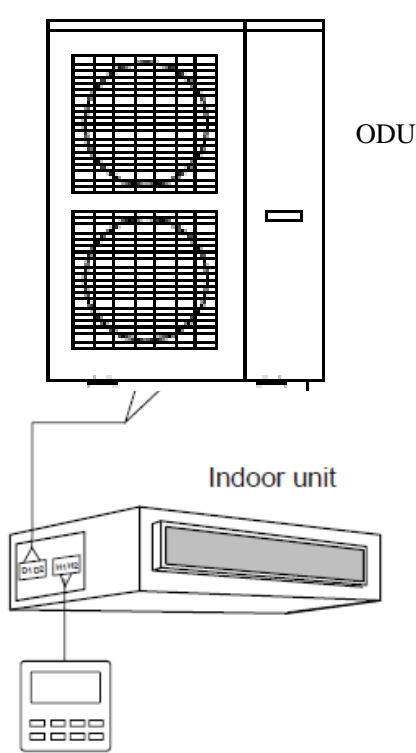

Fig.3 One wired controller controls one indoor unit

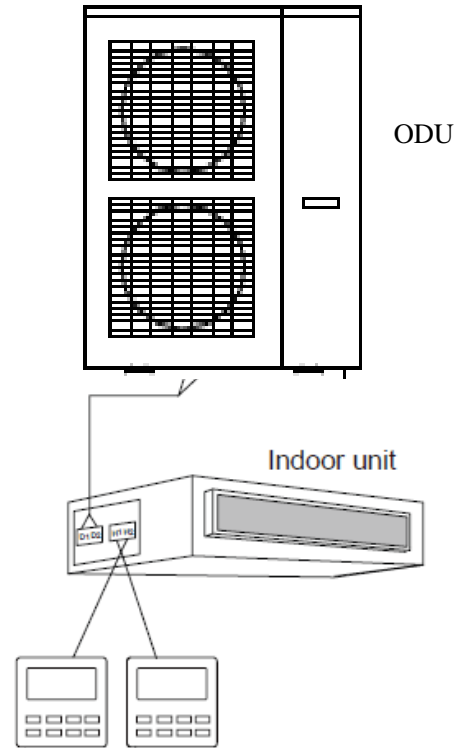

Fig.4 Two wired controllers control one indoor unit

Wiring instructions:

(1) When one wired controller controls multiple indoor units simultaneously, the wired controller can connect to any one indoor unit, but the connected indoor unit must be the same series indoor unit. The total quantity of indoor unit controlled by wired controller can't exceed 16 sets, and the connected indoor unit must be within the

same indoor unit's network.

(2) When two wired controllers control one indoor unit, the addresses of those two wired controllers should be different. Please refer to parameter setting.

(3) When two wired controllers control multiple indoor units, wired controller can be connected to any one indoor unit, while the connected indoor unit should be the same series indoor unit. The addresses of those two wired controllers should be different. Please refer to parameter setting. The total quantity of indoor unit controlled by wired controller can't be more than 16 sets and all connected indoor units must be within the same indoor unit network.

(4) When one (or two) wired controller(s) control(s) multiple indoor units at the same time, the controlled indoor unit's setting should be the same.

(5) Wiring of wired controller and indoor unit network must be according to one of the four wiring methods. As for the connection method shown in fig 2 and 4, there should be only one master wired controller (address is 01) and one slave wired controller (address 02). The quantity of wired controller can't exceed two.

2.2.2 Installation method

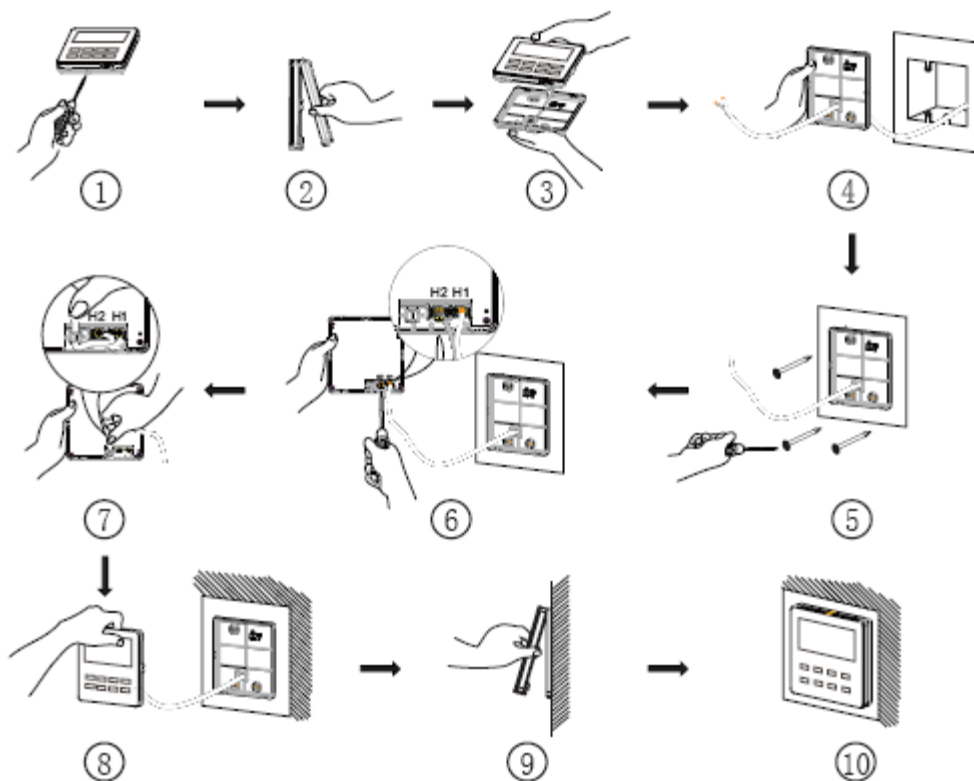

Above is a simple installation method of wired controller. Please pay attention to the following:

- 1) Before installation, disconnect power of the indoor unit. Do not operate when power is connected.
- 2) 2-core twisted pair cable from the installation hole on the wall and lead it through the  shape hole on the back plate of wired controller.
- 3) Place the wired controller on wall and secure its back plate on wall with screw M4X25.

4) Connect the 2-core twisted pair cable to terminal H1 and terminal H2. Tighten up the screws.

5) Set two-core into the groove at left side of wiring column, and then bundle panel and soleplate of wired controller together.

Note: If the wire size of the selected communication line is too large, you can peel some sheath layer of communication wire to satisfy installation requirements

2.2.3 Removal method

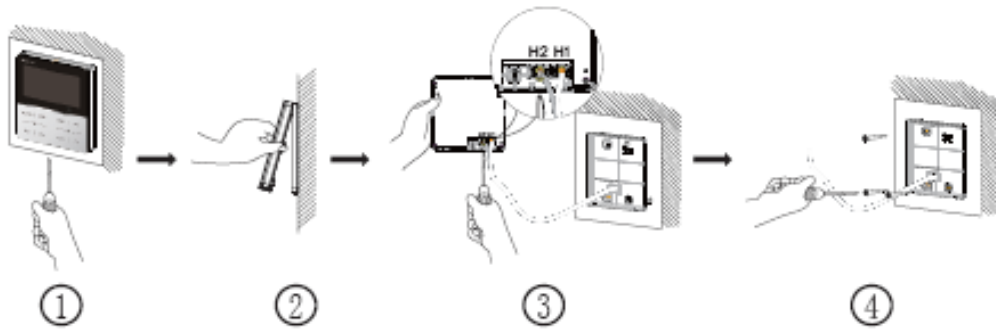

2.3 Engineering Test

1) Mater IDU Settings

In power-off status, press and hold the “MODE” button for five seconds to set the IDU connected with the current wired controller to master IDU. If the setting is successful, MASTER icon will be on.

2) User Parameter Query

Engineering Parameters can be queried in power-on or power-off status.

- (1) Press and hold the “FUNCTION” button for five seconds to enter the user parameter query interface. The temperature area display “C00” and “CHECK” is on.
- (2) Select a parameter code by pressing “^” or “v”
- (3) Press “ENTER/CANCEL” button to return to the upper-level menu till quitting parameter query.

The user parameter query list is as follows:

Parameter Code	Parameter Name	Parameter Range	View Method
C00	Parameter setting ingress	-	-
C01	Project number query of IDU and fault IDU location	1-255: Project number of online IDU	<p>Operation method: In “C01” status, press “MODE” button to enter project number query of IDU. Press “^” or “v” to switch the IDU SN.</p> <p>Display mode: Temperature area: displays the fault of current IDU Timer area: displays project number of current IDU</p> <p>Special operations: After users press the “MODE” button to enter project number query, the buzzer of the IDU operated by the wired controller will ring till users quit “C01” query or</p>

			switch to the next IDU
C03	Indoor unit quantity query in the system network	1-80	Timer area: displays the number of IDUs in the system network.
C06	Preferential operation query	00: Common operation 01: Preferential operation	Operation method: In "C06" status, press "MODE" button to enter Preferential operation query interface. Press "∧" or "∨" to switch the IDU SN. Display mode: Temperature area: displays project number of current IDU Timer area: displays the preferential operation setting value of the current IDU
C07	Indoor environment temperature query	-	Operation method: In "C07" status, press "MODE" button to enter the indoor environment temperature query interface. Press "∧" or "∨" to switch the IDU SN. Display mode: Temperature area: displays project number of current IDU Timer area: displays the temperature value of the environment temperature sensor after replenishment.
C08	Prompt time query for air filter cleaning	4-416: days	Timer area: displays the prompt time query for air filter cleaning
C09	Wired controller address query	01, 02	Timer area: displays the address of the current wired controller
C11	Indoor unit quantity query in one-to-many mode	1-16	Timer area: displays the number of IDUs controlled by the wired controller
C12	Outdoor environment temperature query	-	Timer area: displays the temperature value of the environment temperature sensor of the master ODU.

Note:

- a. In parameter query status, FAN, TIMER, SLEEP, and SWING are invalid. By pressing the "ON/OFF" button, users can return to the main interface but not power on/off the unit.
- b. In parameter query status, signals of the remote controller are invalid.

3) User Parameter Settings

Engineering Parameters can be set in power-on or power-off status.

- (1) Press and hold the "FUNCTION" button for five seconds to enter the user parameter query interface. The temperature area displays "C00". Press and hold the "FUNCTION" button for another five seconds to enter the

wired controller parameter setting interface. The temperature area displays “P00”.

(2) Select a parameter code by pressing “^” or “v”. Press the “MODE” button to switch to parameter value setting. The parameter value blinks. Adjust the parameter value by pressing “^” or “v” and then press the “ENTER/CANCEL” to complete settings.

(3) Press “ENTER/CANCEL” button to return to the upper-level menu till quitting parameter settings.

The user parameter setting list is as follows:

Parameter Code	Parameter Name	Parameter Range	Default Value	Remark
P10	Master IDU settings	00: does not change the master/slave status of the current IDU. 01: sets the current IDU to master IDU	00	After the IDU connected with the current wired controller is successfully set to master IDU, “MASTER” on the wired controller is on.
P11	Infrared connection settings of wired controller	00: disabled 01: enabled	01	This setting can only be enabled through the master wired controller. When the infrared remote receiving function of wired controller is disabled, neither the master nor slave wired controller can receive remote signals. The wired controller can only be operated by pressing.
P13	Wired controller address settings	01: Master wired controller 02: Slave wired controller	01	When two wired controllers simultaneously control one or more IDUs, the two controllers should use different addresses. The slave wired controller (address:02) does not have the unit parameter setting function except its own address settings.
P14	Group-controlled IDU quantity settings	00: disabled 01-16: number of indoor units	01	This value is set based on the number of connected IDUs. If the current value is inconsistent with the actual number of group-controlled IDUs, an “L9” fault may occur.
P30	Static pressure settings for indoor fan	Type 1: 03.04.05.06.07 Type 2: 01.02.03.04.05.06.07.08.09	05	After identifying the IDU type, the wired controller only displays the available static pressure levels. 1. The static pressure levels fall into five levels and nine levels for VRF IDUs. The wired controller only displays the static pressure levels matched with the identified IDU type. 2. When the HBS network consists of IDUs with both five and nine static

				pressure levels according to the maximum control principle.If the static pressure levels received by the IDU from wired controller,remote controller,or remote monitoring system exceed the setting range,the limit value prevails. 3. During power-on and synchronization the setting value of static pressure levels is determined by setting of the IDU.
P31	Hign-ceiling installation	00:standard-ceiling installation height 01: high-ceiling installation height	00	
P33	Timer function settings	00: common timing 01: time-point timing	00	
P34	Repeating validity for time-point timing	00: single timing 01: repeated everyday	00	This setting is valid only when the timer function is set to time-point timing.
P37	Cooling setting temperature in automatic mode	17°C~30°C	25°C	Cooling setting temperature – heating setting temperature ≥1°C.
P38	Heating setting temperature in automatic mode	16°C~29°C	20°C	Note: The two settings are still valid in remote shielding status.
P43	Preferential operation settings	00: common operation 01: preferential operation	00	When power supply is insufficient, users are allowed to power on/off the IDU set with preferential operation and other IDUs are forcibly powered off.A fault code is displayed on the IDU that is forcibly powered off.
P46	Accumulated time clearing for air filter cleaning	00: not cleared 01: cleared	00	

Note:

- a. In parameter query status, FAN, TIMER, SLEEP, and SWING are invalid. By pressing the "ON/OFF" button, users can return to the main interface but not power on/off the unit.
- b. In parameter query status, signals of the remote controller are invalid.

2.4 Operation Instructions

1) On/Off

Press ON/OFF button to turn on the unit.

Press ON/OFF button again to turn off the unit.

The interfaces of On/Off status are shown as follow:

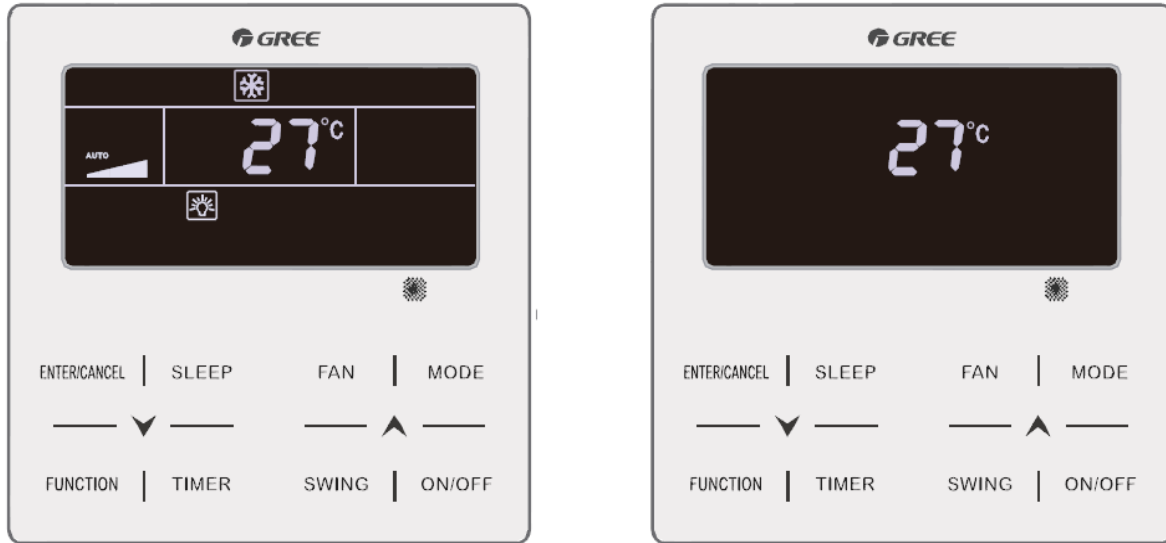

2) Mode Setting

Under On status, pressing MODE button can set mode circularly as:

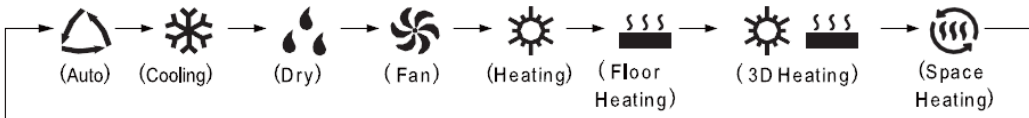

OR

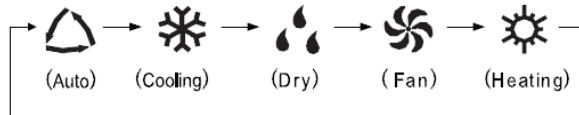

Note:

① There will be different mode with different model of the unit. The wired controller will select the range of setting mode according to the model of indoor unit

② Only in master indoor unit that AUTO mode can be set.

③ Under the AUTO mode, when the indoor unit is cooling, “” and “” will be on; when the indoor unit is heating, “” and “” will be on.

3) Temperature Setting

Pressing “ or ” button in On status increases or decreases set temperature by 1 °C; holding “ or ” button increases or decreases set temperature by 1 °C every 0.3s.

In Cooling, Fan, Heating, Floor Heating, 3D Heating or Space Heating mode, temperature setting range is 16 °C~30 °C.

In Dry mode, the temperature setting range is 12 °C, 16 °C~30 °C. In Dry mode, when temperature is 16 °C,

continuously press “V” button twice to decrease temperature to 12°C (when Save function is activated, the temperature in Dry mode can't be adjusted to 12°C and the setting range is “lowest temperature in Save mode” ~ 30 °C).

Note:

① Under Auto mode or Out function is activated, the setting temperature can not be adjusted by pressing “^” or “V”

② When the wired controller is connected with a Fresh Air Indoor Unit, setting temperature won't be displayed and can't be adjusted via “^” or “V” button. The air outlet temperature in cooling or heating can only be set in the parameter setting status.

4) Fan Speed Setting

Under On status, pressing FAN button can set fan speed circularly as:

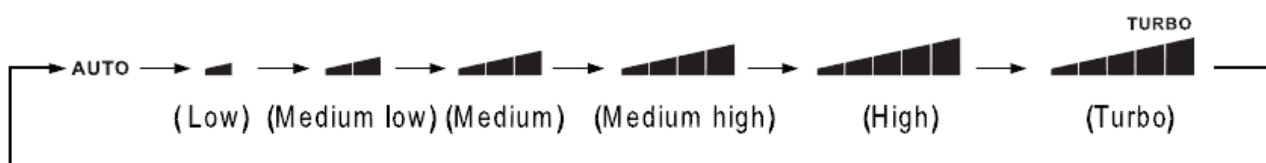

Note: Under the DRY mode, the fan will be kept running at the low speed and the fan speed isn't adjustable

5) Timer setting

The wired controller is equipped with two kinds of timer: general timer and clock timer. General timer is factory defaulted setting. Please refer to parameter setting

a. General Timer

Unit On/Off after a desired hour can be set through general timer.

Set Timer: when timer is not set, press TIMER button to enter timer setting and “HOUR” icon is blinking. Press “^” or “V” button to adjust timer time. Press TIMER button to save the setting and then exit setting.

Cancel Timer: when timer is set, press TIMER button to cancel it.

Timer setting range: 0.5~24h. Pressing “^” or “V” button increases or decreases timer time by 0.5h; holding “^” or “V” button increases or decreases timer time by 0.5h every 0.3s.

In unit On status, timer Off setting is shown as follow:

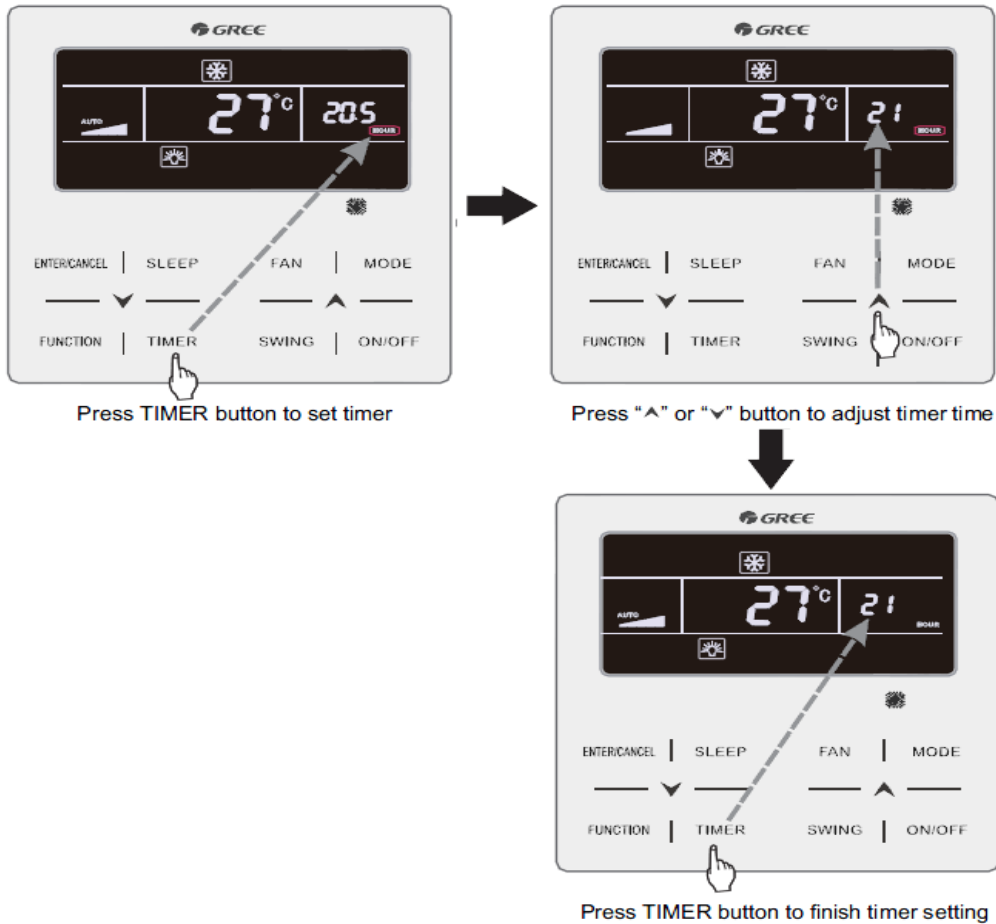

b. Clock Setting Clock display: when the timer setting way is clock timer, timer zone displays system clock in unit On and Off status. “🕒” icon is bright and the clock can be set at this time.

Clock setting: long press TIMER button for 5s to enter clock setting and “🕒” icon is blinking. Pressing “▲” or “▼” button increases or decreases clock time by 1min; holding “▲” or “▼” button for 5s increases or decreases clock time by 10min; Press ENTER/CANCEL button or TIMER button to save the setting and then exit setting.

c. Clock Timer

Unit On/Off at a certain time can be set through clock timer.

Set Timer:

- (1) Press TIMER button to enter timer on setting and the “ON” icon is blinking;
- (2) Press “▲” or “▼” button to adjust unit On time. Press ENTER/CANCEL button to finish setting;
- (3) Before pressing ENTER/CANCEL button, pressing TIMER button can save unit On time and then switch to unit Off time setting with “OFF” icon blinking;
- (4) Press “▲” or “▼” button to adjust unit Off time. Press ENTER/CANCEL button to finish setting;

Cancel Timer:

Press TIMER button to enter timer setting; press TIMER button again to switch to the setting of unit ON time or unit Off time; press ENTER/CANCEL button to cancel timer.

Pressing “^” or “v” button increases or decreases timer time by 1min; holding “^” or “v” button for 5s increases or decreases timer time by 10min.

Clock Timer setting is shown as follow:

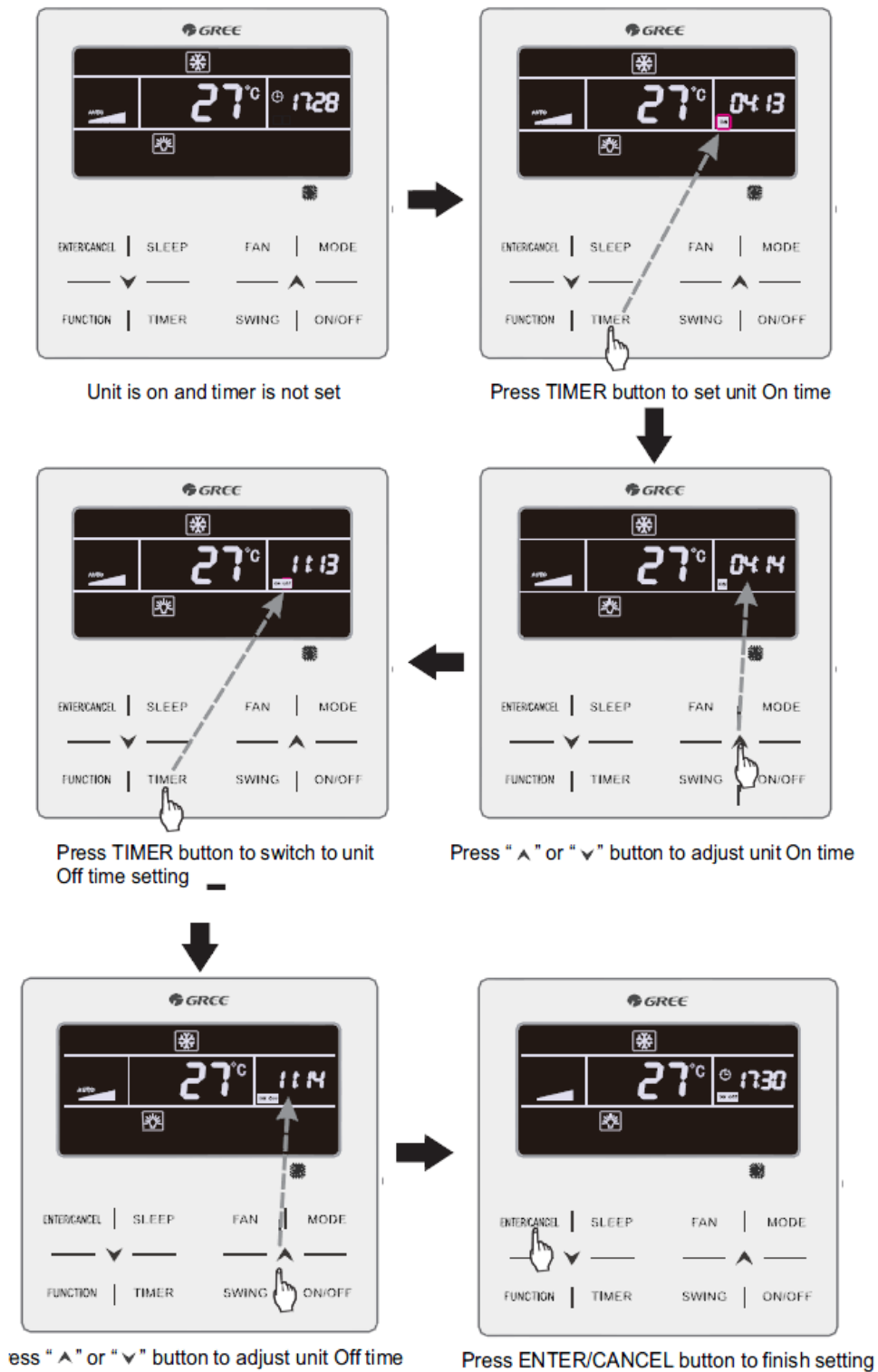

6) Swing Setting In unit on status, up & down swing function and left & right swing function can be set.

(1) Up & down swing function

Up & down swing function has two modes: simple swing mode and fixed-angle swing mode. In unit off status, press “SWING” button and ▲ button together for 5 seconds to switch between simple swing mode and fixed-angle swing mode. Up & down swing icon  will blink during switching.

- a. When simple swing mode is set in unit on status, press “SWING” button to start or stop up & down swing.
- b. When fixed-angle swing mode is set in unit on status, press “SWING” button to adjust swing angle circularly as below:

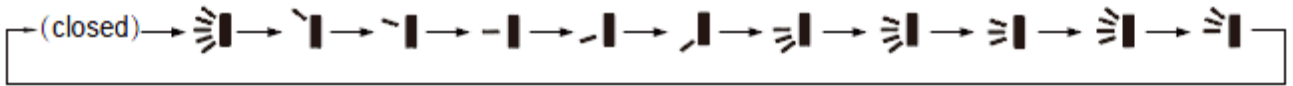

(2) Left & right swing function



Start left & right swing: In unit on status, press “FUNCTION” button to switch to left & right swing function with left & right swing icon  blinking, and then press “ENTER/CANCEL” button to start left & right swing.

When left & right swing is activated, left & right swing icon  will be bright.

Cancel left & right swing: When left & right swing is activated, press “FUNCTION” button to switch to left & right swing with left & right swing icon  blinking, and then press “ENTER/ CANCEL” button to cancel left & right swing.

7) Quiet Setting

Quiet Function: decrease the noise of indoor unit and achieve the quiet effect. Quiet function has two modes: Quiet mode and Auto Quiet mode. It is available only in Auto, Cooling, Dry, Fan, Heating, 3D heating, Space heating mode.

Turn on Quiet Function: press FUNCTION button to turn to Quiet function and then Quiet icon  or auto quiet icon  is blinking. At this moment, press “^” or “v” button to switch between quiet and auto quiet, and then press ENTER/CANCEL button to activate.

Turn off Quiet Function: press FUNCTION button to turn to Quiet function and then press ENTER/CANCEL button to cancel Quiet function.

The setting of Quiet function is shown as follow:

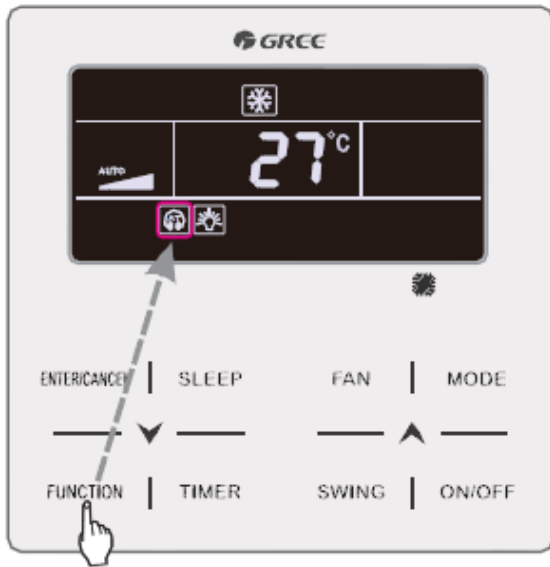

Press FUNCTION button to turn to Quiet function



Press "▲" or "▼" button to switch between Quiet and Auto Quiet



Press ENTER/CANCEL button to activate Quiet function

8) Sleep Setting

Sleep Function: in this mode, the unit will operate according to the preset sleep curve to provide comfortable sleep environment.

Turn on/off Sleep Function: in unit On status, press SLEEP button to activate or cancel Sleep function.

When Sleep function is activated, "☾" icon is bright and quiet or auto quiet mode is also activated.

When Sleep function is closed, if quiet function is activated before starting Sleep function, only sleep function

is closed while quiet function is still activated;

Under Auto, Fan or Floor Heating mode, this Sleep function is not available.

9) Air Setting

Air Function: Adjust the amount of indoor fresh air to improve air quality and keep indoor air fresh.

Turn on Air Function: When unit is on or off, press FUNCTION button and select Air.  icon will blink and the unit enters into Air setting. Temperature zone shows the level of Air setting, which can be adjusted by pressing “^” or “v” button. The adjustment range is 1~10. Press ENTER/ CANCEL button to turn on Air function.

Turn off Air Function: When Air function is on, press FUNCTION button to select Air, then press ENTER/CANCEL button to cancel this setting.

The setting of Air function function is shown as follow:

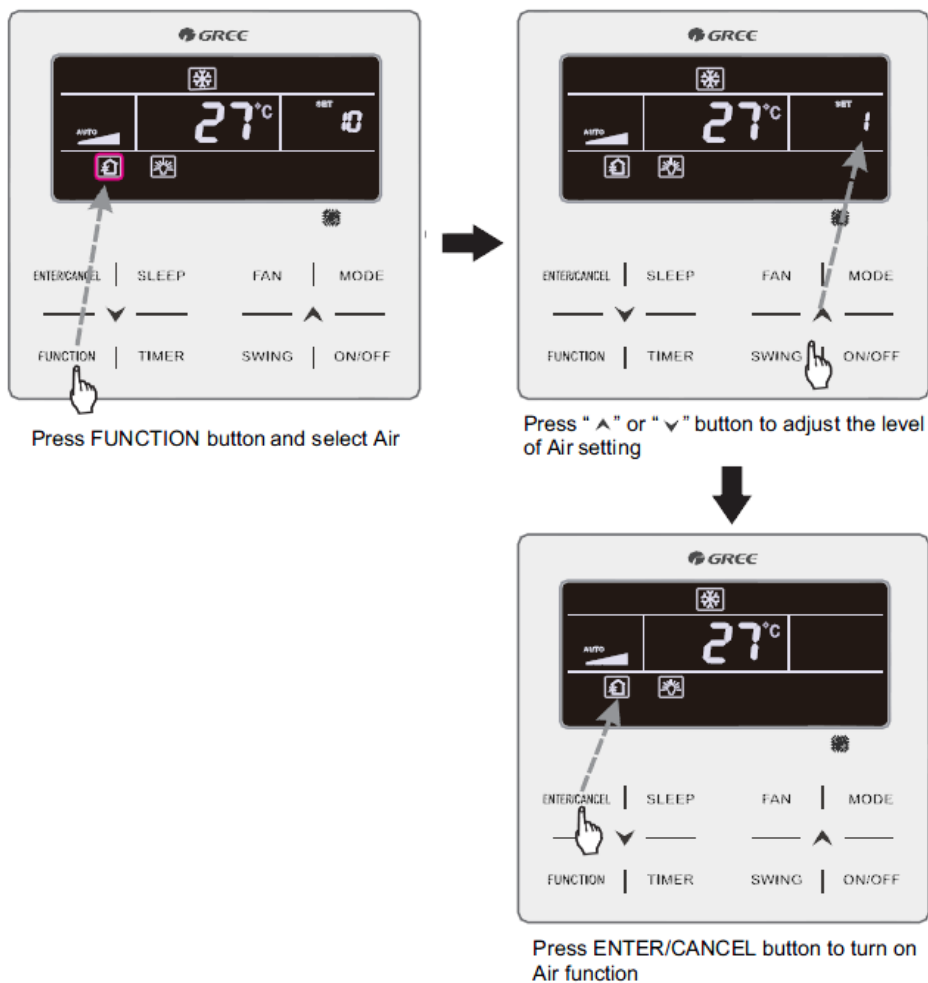

10) Light On/Off Setting

Light On/Off Function: Light of indoor unit can be turned on or off.

Turn on the Light: When unit is on or off, press FUNCTION button to select Light function.  icon will blink. Press ENTER/CANCEL to turn on the light.

Turn off the Light: When light of indoor unit is on, press FUNCTION button to select Light. Then press ENTER/CANCEL to turn off the light.

Note:

When there is no button operation on the wired controller or no remote control signal is received for 20s continuously:

- ① If Light function is activated, the back light of LCD will turn to half bright.
- ② If Light function is off, the back light of LCD will be off.

11) Save Setting

Save Function: Air conditioner can be operated in small temperature range by setting the minimum temperature under Cooling and Dry modes and setting maximum temperature under Heating, 3D Heating and Space Heating modes. Thus, energy saving can be realized.

Save Setting:

Save Setting for Cooling: When unit is on and under Cooling or Dry mode, press FUNCTION button to select Save function.  icon will blink and MIN icon lit up. Press“^”or“v” button to adjust to the minimum temperature. Press ENTER/CANCEL button to activate this function.

The setting of Save function is shown as follow:

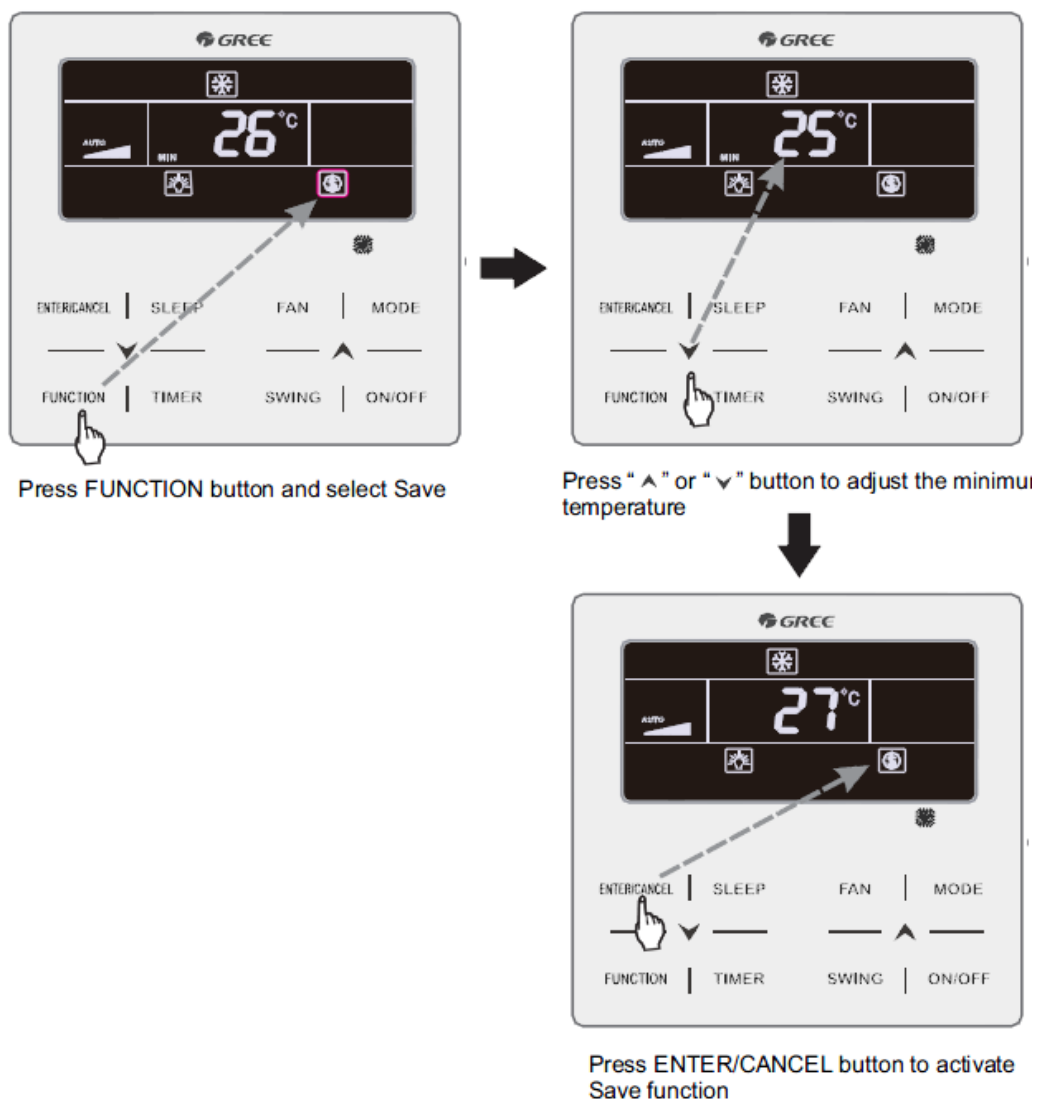



Save Setting for Heating: When unit is on and under Heating, 3D Heating and Space Heating modes, press FUNCTION button to select Save function.  icon will blink and MAX icon lit up. Press “^” or “v” button to adjust the MAXIMUM temperature. Press ENTER/CANCEL button to turn on this function.

Turn off Save Function: Press FUNCTION button and select Save function.  icon blinks. Then press ENTER/CANCEL button to cancel this setting.

12) Filter Clean Reminder Setting

Filter Clean Reminder Function: Unit will remember its own operating time. When the setting time is up, this function will remind you to clean the filter. A dirty filter will result in bad heating and cooling performance, abnormal protection, bacteria gathering, etc.

Turn on Filter Clean Reminder Function: When unit is on, press FUNCTION button and select Filter Clean Reminder.  icon will blink. Press “^” or “v” button to adjust the cleaning level, of which the range is 00, 10-39. Press ENTER/CANCEL to turn on this function.

Turn off Filter Clean Reminder Function: When unit is on and this function has been turned on, press FUNCTION button and select Clean. Then  icon will blink. Set the cleaning level as 00 and press ENTER/CANCEL function to cancel this setting.

When Filter Clean Reminder time is up,  icon will light up to remind you to clean the filter. Press FUNCTION button to turn to Filter Clean Reminder Function, then press SWING/ ENTER to cancel reminding, and it will retime according to the original cleaning level. The clean reminding can be cancel only when you didn't reset the cleaning level under the setting of Filter Clean Reminder Function.

The setting of Filter Clean Reminder function is shown as follow:

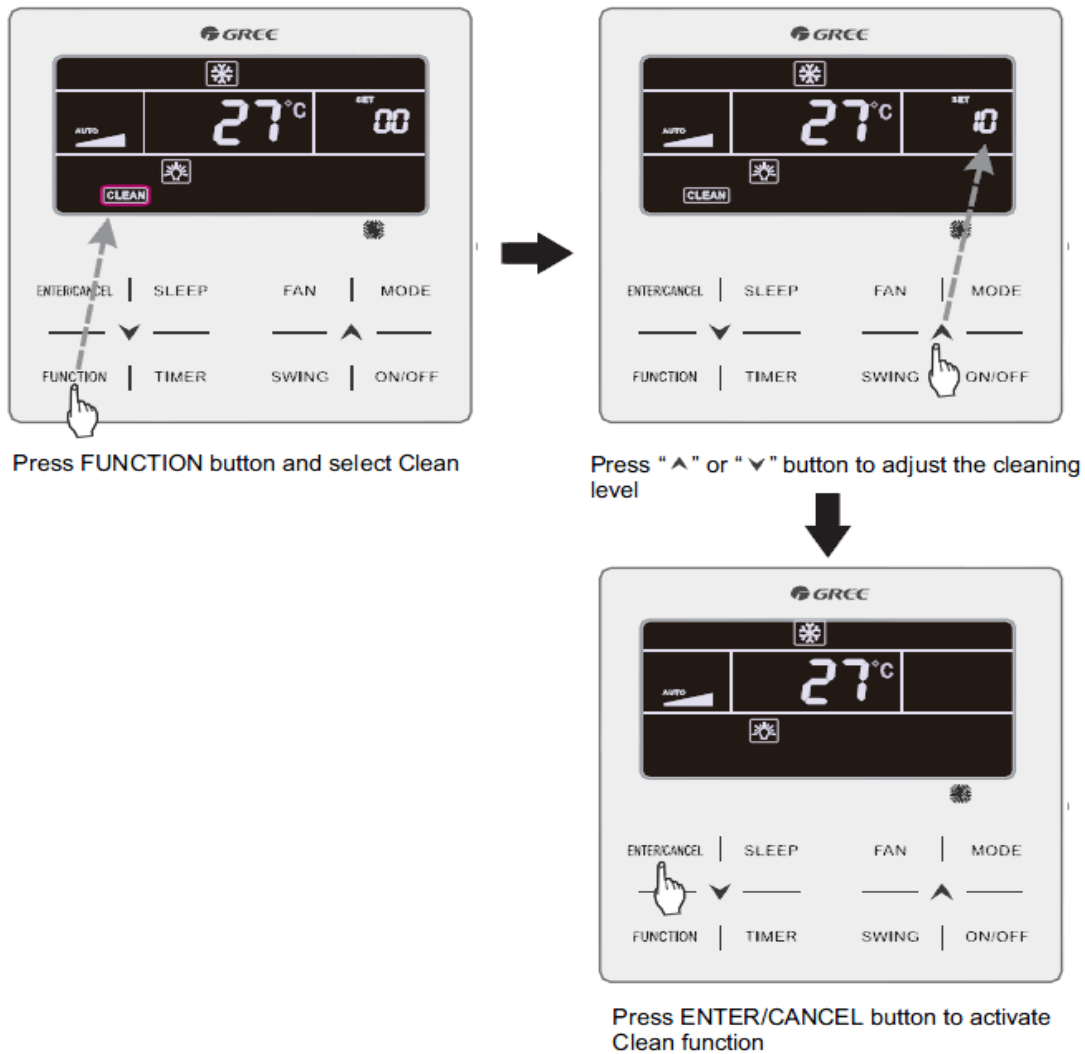

Note:

Description on cleaning level: When setting the Filter Clean Reminder Function, timer zone will display 2 digits, of which the former indicates the pollution degree of operating place and the latter indicates the operating time of indoor unit. There are 4 types of situations :

Cleaning Level	Description of Levels
Turn off Clean Reminder	Timer zone shows 00
Slight Pollution	The former digit shows 1 while the latter one shows 0, which indicates the accumulating operating time is 5500 hours. Each time the latter digit increases 1, the operating time increases 500 hours. When it reaches 9, it means the operating time is 10000 hours
Medium Pollution	The former digit shows 2 while the latter one shows 0, which indicates the accumulating operating time is 1400 hours. Each time the latter digit increases 1, the operating time increases 400 hours. When it reaches 9, it means the operating time is 5000 hours

Heavy Pollution	The former digit shows 3 while the latter one shows 0, which indicates the accumulating operating time is 100 hours. Each time the latter digit increases 1, the operating time increases 100 hours. When it reaches 9, it means the operating time is 1000 hours.
-----------------	--

13) X-fan Setting

X-fan Function: If unit is turned off under Cooling or Dry mode, the evaporator of indoor unit will be dried off automatically to prevent bacteria and mould from gathering.

Turn on X-fan: When unit is on or under Cooling or Dry mode, press FUNCTION button to select X-fan.  icon will blink. Then press ENTER/CANCEL button to turn on this function.

Turn off X-fan: When X-fan function is on, press FUNCTION button to select X-fan.  icon will blink. Then press ENTER/CANCEL button to turn off this function.

14) Out Setting

Out Function: This is used to maintain indoor temperature so that unit can realize fast heating after it is turned on. This function can only be used under Heating mode.



Turn on Out Function: Under Heating mode, press FUNCTION button to select Out.  icon will blink. Then press ENTER/CANCEL button to turn on this function.

Turn off Out Function: When this function is on, press FUNCTION button to select Out.  icon will blink. Then press ENTER/CANCEL button to turn off this function.

15) Remote Shield Function

Remote Shield Function: Remote monitor or central controller can disable the relevant functions of wired controller so as to realize the function of remote control.

Remote Shield Function includes all shield and partial shield. When All Shield function is on, all controls of the wired controller are disabled. When Partial Shield function is on, those controls that are shielded will be disabled.

When the remote monitor or central controller activates Remote Shield on the wired controller,  icon will show. If user wants to control through the wired controller,  icon will blink to remind that these controls are disabled.

16) Child Lock Function

When unit is turned on normally or turned off, pressing “^” or “v” button together for 5 seconds will turn on Child Lock function.  will show on the display. Pressing “^” or “v” together again for 5 seconds to turn off this function.

All the other buttons will be disabled when Child Lock function is on.

17) Gate-control Function

When there is Gate-control System, user can insert a card to turn on the unit or pull off a card to turn off the unit. When the card is re-inserted, the unit will recover the operation as state in memory. When the card is pulled off (or improperly inserted),  icon will show.

2.5 Error display

When there occurs any error during operation, the temperature display zone on the wired controller will show error codes. If several errors happen at the same time, error codes will show on the display repeatedly.

Note: If error occurs, please turn off the unit and send for professionals to repair.

The display of Outdoor Unit High Pressure Protection when unit is on is shown as follow:



2.5.1 Table of Error Codes for Outdoor Unit

Display Code	Content	Display Code	Content	Display Code	Content
E0	Malfunction of outdoor unit	FH	Abnormal current sensor for compressor1	b1	Malfunction for outdoor ambient temperature sensor
E1	Compressor high pressure protection	FC	Abnormal current sensor for compressor2	b2	Maflunction of defrosting temperature sensor 1
E2	Low-temperature protection for discharge	FL	Abnormal current sensor for compressor3	b3	Maflunction of defrosting temperature sensor 2
E3	Compressor low pressure protection	FE	Abnormal current sensor for compressor4	b4	Malfunction of liquid temperature sensor for subcooler
E4	Compressor high discharge temperature protection	FF	Abnormal current sensor for compressor5	b5	Malfunction of gas temperature sensor for subcooler

EC	Loose protection for discharge temperature sensor for compressor 1	FJ	Abnormal current sensor for compressor6	b6	Malfunction of suction temperature sensor1
EL	Loose protection for discharge temperature sensor for compressor 2	FU	Malfunction of casing top temperature sensor for compressor1	b7	Malfunction of suction temperature sensor2
EE	Loose protection for discharge temperature sensor for compressor 3	Fb	Malfunction of casing top temperature sensor for compressor2	b8	Malfunction for outdoor ambient humidity sensor
EF	Loose protection for discharge temperature sensor for compressor 4	J1	Overcurrent protection for compressor 1	b9	Malfunction of gas exit temperature sensor for heat exchanger
EJ	Loose protection for discharge temperature sensor for compressor 5	J2	Overcurrent protection for compressor 2	bA	Malfunction of oil return temperature sensor
EP	Loose protection for discharge temperature sensor for compressor 6	J3	Overcurrent protection for compressor 3	bH	Abnormal clock of system
F0	Poor main board of outdoor unit	J4	Overcurrent protection for compressor 4	bC	Loose protection for casing top temperature sensor for compressor 1
F1	Malfunction of high pressure sensor	J5	Overcurrent protection for compressor6	bL	Loose protection for casing top temperature sensor for compressor 2
F3	Malfunction of low pressure sensor	J6	Overcurrent protection for compressor 6	P0	Malfunction driven board for compressor
F5	Malfunction of discharge temperature sensor of compressor 1	J7	Air-mixing protection for 4-way valve	P1	Driven board of compressor works abnormally
F6	Malfunction of discharge temperature sensor of compressor 2	J8	High pressure ratio protection of system	P2	Power voltage protection for the driven board of compressor
F7	Malfunction of discharge temperature sensor of compressor 3	J9	Low pressure ratio protection of system	P3	Reset protection for the driven module of compressor
F8	Malfunction of discharge temperature sensor of compressor 4	JA	Abnormal pressure protection	H0	Malfunction driven board for fan
F9	Malfunction of discharge temperature sensor of compressor 5	JC	Waterflow switch protection	H1	Driven board of fan works abnormally
FA	Malfunction of discharge temperature sensor of compressor 6	JL	High pressure is too low	H2	Power supply voltage protection of fan motor drive board

2.5.2 Table of Error Codes for Indoor Unit

Display Code	Content	Display Code	Content	Display Code	Content
L0	Malfunction of indoor unit	LA	Wrong series for one-to-more indoor unit	d9	Malfunction of jumper cap
L1	Indoor fan protection	LH	Alarming due to bad air quality	dA	Abnormal address for indoor unit
L2	E-heater protection	LC	The indoor unit model can't match with outdoor unit model	dH	Abnormal PCB for wired controller
L3	Water overflow protection	d1	Poor indoor PCB	dC	Abnormal code-dialing setting of capacity
L4	Overcurrent protection	d3	Malfunction of ambient temperature sensor	dL	Malfunction of air exhaust temperature sensor
L5	Freeze prevention protection	d4	Malfunction of entry tube temperature sensor	dE	Malfunction of indoor CO2 sensor
L7	No main indoor unit	d6	Malfunction of exit tube temperature sensor	db	Special code: engineering debugging code
L8	Insufficient power supply	d7	Malfunction of humidity sensor		
L9	Wrong number of indoor unit for one-to-more indoor unit	d8	Malfunction of water temperature sensor		

2.5.3 Table of Debugging Codes

Display Code	Content	Display Code	Content	Display Code	Content
U2	Capacity code of outdoor unit/wrong setting of jumper cap	UE	Refrigerant-charging is invalid	CH	High rated capacity
U3	Phase-lacking protection of power	UL	Wrong code-dialing during emergency operation	CL	Low rated capacity
U4	Insufficient refrigerant protection	C0	Communication malfunction for indoor unit, outdoor unit and wired controller of indoor unit	CF	Malfunction of main control unit
U5	Wrong address for the driven board of compressor	C2	Driven communication malfunction between	CJ	Address shock of syste



			main board and inverter compressor		
U6	Alarm due to abnormal valve	C3	Driven communication malfunction between main board and inverter compressor	CP	Much master wired controller malfunction
U8	Malfunction of pipeline for indoor unit	C4	Malfunction of indoor unit-lacking	CU	Communication malfunction between indoor unit receiving lamp board
U9	Malfunction of pipeline for outdoor unit	C5	Alarming due to engineering series number shock of indoor unit	Cb	Distribution overflow of Ip address
UC	Setting for indoor unit and outdoor unit is succeeded	C6	Alarming due to wrong quantity of outdoor unit		

2.5.4 Table of Status Codes

Display Code	Content	Display Code	Content
A0	Debugging for unit	A8	Vacuum pump mode
A1	parameter inquiry of compressor	AJ	Cleaning alarm for filter
A2	Refrigerant recovery	AU	Long-distance emergency stop
A3	Defrosting	Ab	Emergency stop
A5	On-line test	Ad	Limit operation

3 REMOTE CONTROLLER

3.1 Remote controller YAD1F

3.1.1 User Notes

- 1) Make sure that there is no obstruction between the remote control and the signal receptor.
- 2) The remote control should be used in the receivable range (the reception range is 10m)
- 3) The remote control should be placed about 1m or more from the TV set or any other electric appliances.
- 4) When the remote controll is sending signal the  symbol will blink for about 1 second. The master unit will ring out when it receive the valid signal.
- 5) Don't drop or throw the remote control.
- 6) Don't let any liquid flow into the remote control.
- 7) Don't put the remote control directly under the sunlight or any place where is very hot.
- 8) Different unit may have different function, for more details function please refer to the instruction of the unit.

3.1.2 Button name and function introduction

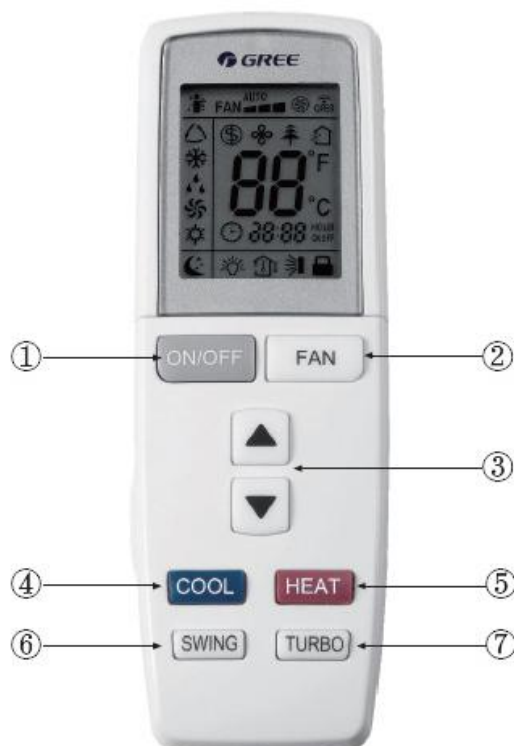

1) Button name and function introduction (outside)

No.	Button name	Function
1	ON/OFF	Turn on or turn off the unit
2	FAN	Set fan speed
3	▲/▼	Set temperature and time
4	COOL	Set cooling function
5	HEAT	Set heating function
6	SWING	Set swing status
7	TURBO	Set turbo function

2) Button name and function introduction (inside)

No.	Button name	Function
1	MODE	Set operation mode
2	TIMER ON	Set timer on function
3	TIMER OFF	Set timer off function
4	LIGHT	Set light function
5	I FEEL	Set I FEEL function
6	X-FAN	Set X-FAN function
7	TEMP	Switch temperature displaying type on the unit's display
8	HEALTH	Set health function
9	CLOCK	Set clock of the system
10	SLEEP	Set sleep function



3.2 YV1L1



3.2.1 User Notes

- 1) Make sure that there is no obstruction between the remote control and the signal receptor.
- 2) Don't drop or throw the remote control.
- 3) Don't put the remote control directly under the sunlight or any place where is very hot.
- 4) The remote control signal can be received at the distance of up to about 10m.
- 5) Don't let any liquid flow into the remote control.
 - For duct type of indoor unit, the wired controller is optional parts.

3.2.2 Button name and function introduction



No.	Button Name	Function
1	ON/OFF	Turn on or turn off the unit
2	FAN	Set fan speed
3	▲/▼	Set temperature and time
4	MODE	Set operation mode
5		Set quiet function
6		Set health function and air function

7		Set left&right swing status
8		Set up&down swing status
9	X-FAN	Set X-FAN function
10	TIMER ON	Set timer on function
11	TIMER OFF	Set timer off function
12	SAVE	Set energy-saving function
13	SLEEP	Set sleep function
14	LIGHT	Set light function
15	CLOCK	Set clock of the system
16	I FEEL	Set I FEEL function
17	TEMP	Switch temperature displaying type on the unit's display



INSTALLATION

INSTALLATION

1 TOOLS AND EQUIPMENT FOR INSTALLATION AND MAINTENANCE

- ◆Triple distribution box----- Fig.1
- ◆Multi-function meter----- Fig.2
- ◆Control valve----- Fig.3

It can avoid refrigerant overflow when moving the refrigerant, it can make the liquid tube and liquid filling port opening are closing in an instant.

- ◆Filling safty equipment (Gas Liquid Seperator) ----- Fig.4

In general, the refrigerant must be converted to liquid, because refrigerant R410A is a mixed system, if the combined ratio changes there will be a certain risk. In order to avoid the refrigerant return to compressor in liquid, you can use this device to make refrigerant safely entering the compressor.

- ◆Eletronic balance----- Fig.5

The recommended equipment for filling R410A

- ◆Refrigerant storage tank----- Fig.6

It must confirm the type of refrigerant before filling, liquid refrigerant is filled usually.

- ◆Thermistor vacuum gauge----- Fig.7

In ordet to completely remove Refrigerant vapor, take appropriate vacuum is necessary. You can use this device to determine whether the system is a vacuum environment.

- ◆Vacuum pump----- Fig.8

- ◆Welding tools----- Fig.9

- ◆Tube bender----- Fig.10

- ◆Tube expander----- Fig.11

In order to adapt to high pressure characteristics of R410A, the shape of the tube expander is different from the conventional expander

- ◆Nitrogen tank----- Fig.12

- ◆Phillips/slotted screwdriver----- Fig.13

- ◆Pliers----- Fig.14

- ◆Monkey wrench8/12----- Fig.15

- ◆Torque wrench----- Fig.16

- ◆Double pressure gauge----- Fig.17

- ◆Level----- Fig.18

- ◆Impact electric hammer----- Fig.19

- ◆Electric drill----- Fig.20

- ◆Oxygen pressure reducing valve, Nitrogen pressure reducing valve, Acetylene pressure reducing valve, Back valve----- Fig.21

- ◆Gas leak detector ----- Fig.22

◆Refrigerant cleaner----- Fig.23

◆Refrigerant recovery equipment (Collector) ----- Fig.24

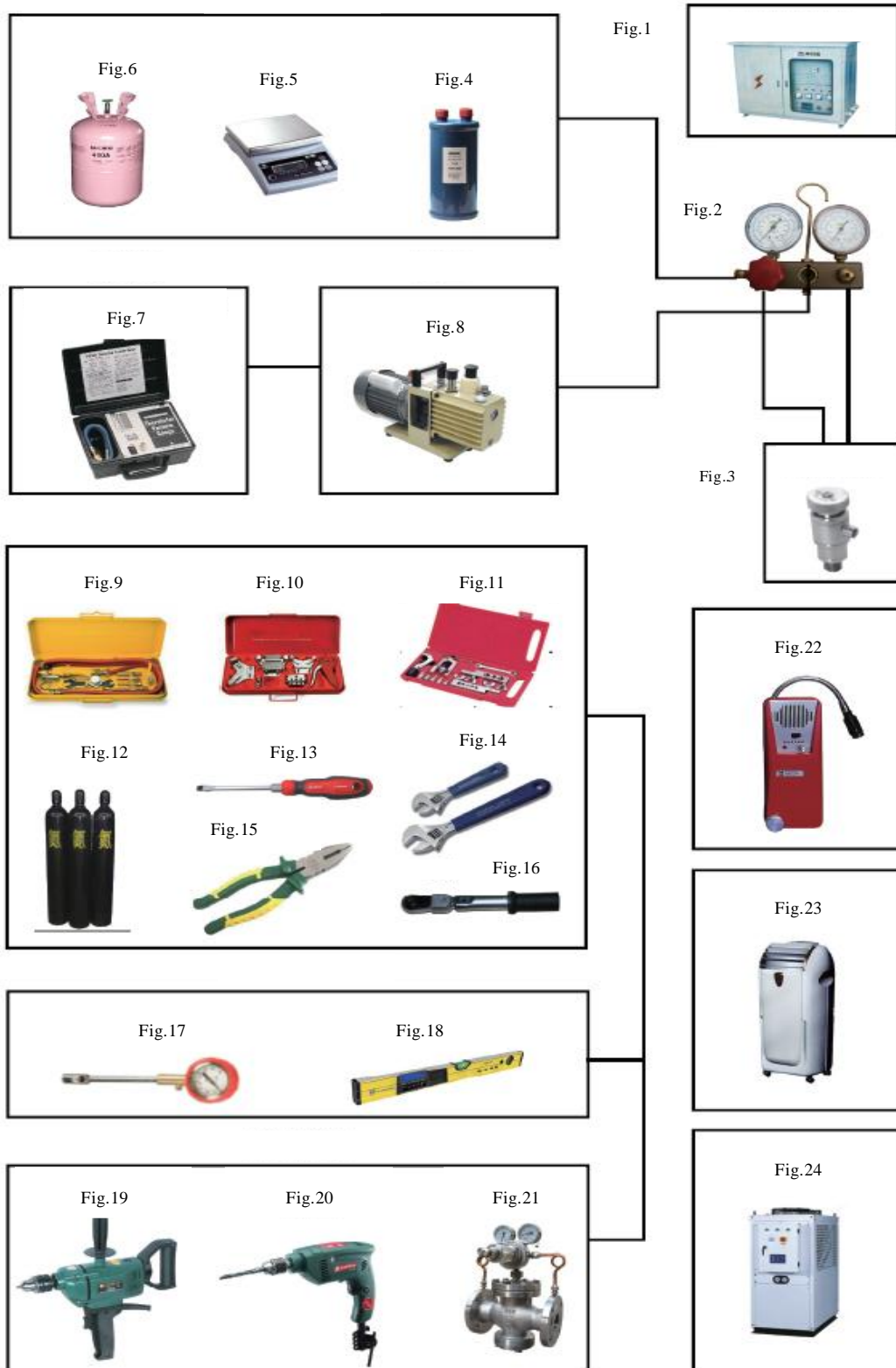

2 INSTALLATION KEY POINTS AND IMPORTANCE

2.1 Installation notice

Personnel and property safety are highly concerned during the entire installation process. Installation implementation must abide by relevant national safety regulations to ensure personnel and property safety. All personnel involved in the installation must attend safety education courses and pass corresponding safety examinations before installation. Only qualified personnel can attend the installation. Relevant personnel must be held responsible for any violation of the regulation.

2.2 Installation key points and importance

VRF air conditioning systems use refrigerant, instead of other agent, to directly evaporate to carry out the system heat. High level of pipe cleanness and dryness is required in the system. Since various pipes need to be prepared and laid out onsite, carelessness or maloperation during installation may leave impurities, water, or dust inside refrigerant pipes. If the design fails to meet the requirement, various problems may occur in the system or even lead to system breakdown.

Problems that usually occur during installation are as follows:

No.	Installation problem	Possible Consequence
1	Dust or impurities enter into the refrigeration system	Pipes are more likely to be blocked; air conditioning performance is reduced; compressor wear is increased or even hinder the normal operation of the system and burn the compressor.
2	Nitrogen is not filled into the refrigerant pipe or insufficient Nitrogen is filled before welding.	Pipes are more likely to be blocked; air conditioning performance is reduced; compressor wear is increased or even hinder the normal operation of the system and burn the compressor
3	The vacuum degree in the refrigerant pipe is insufficient	The refrigeration performance is reduced. The system fails to keep normal operation due to frequent protection measures. When the problem getting serious, compressor and other major components can be damaged.
4	Water enters into the refrigeration system	Copper plating may appear on the compressor and reduce the compressor efficiency with abnormal noise generated; failures may occur in the system due to ice plug
5	The refrigerant pipe specifications do not meet the configuration requirements	Smaller configuration specifications can increase the system pipe resistance and affect the cooling performance; larger configuration specifications are waste of materials and can also reduce the cooling performance
6	Refrigerant pipe is blocked.	The cooling performance is reduced; in certain cases, it may cause long-term compressor operating under overheat conditions; the lubricating effect can be affected and the compressor may be burnt if

		impurities were mixed with the lubricating oil
7	Refrigerant pipe exceeds the limit.	The loss in pipe is considerable and the unit energy efficiency decreases, which are harmful for long-term running of the system.
8	Incorrect amount of refrigerant is filled.	The system cannot correctly control the flow allocation; the compressor may be operating under over-heating environment or running when the refrigerant flows back to the compressor
9	The refrigerant pipe leaks	Insufficient refrigerant circulating in the system decreases the cooling performance of the air conditioner. Long-term operation under such circumstance may cause an overheating compressor or even damage the compressor.
10	Water drainage from the condensate water pipe is not smooth	Residual water in IDUs can affect the normal operation of the system. The possible water leakage can damage the IDU's decoration.
11	The ratio of slop for condensate water pipe is insufficient or the condensate water pipe is incorrectly connected	Reverse slop or inconsistent connection of condensate water pipe can hinder the smooth drainage and cause leakage of the IDU.
12	The air channel is improperly fixed.	The air channel will deform; vibration and noise occur during unit operating.
13	The guide vane of air channel is not reasonably manufactured.	Uneven air quantity allocation reduces the overall performance of the air conditioner
14	The refrigerant pipe or condensate water pipe does not meet the insulation requirement.	Water can easily condensate and drip to damage the indoor decoration, or even trigger the protection mode of system due to overheating operation
15	The installation space for IDU is insufficient.	Since there is a lack of space for maintenance and checking, indoor decoration might need to be damaged during such operation
16	The IDU or the location of the air outlet or return air inlet is not designed reasonably.	The air outlet or return air inlet may be short-circuited, thus affecting the air conditioning performance
17	The ODU is improperly installed	The ODU is difficult to be maintained; unit exhaust is not smooth, which reduces the heat exchanging performance or even prevent the system from normal operation; in addition, the cold and hot air for heat exchange and the noise may annoy people in surrounding areas
18	Power cables are incorrectly provided	Unit components may be damaged and potential safety hazard may occur
19	Control communication cables are incorrectly provided or improperly connected.	The normal communication in the system fails or the control over IDUs and ODUs turn in a mess
20	Control communication cables are not properly protected.	The communication cables are short-circuited or disconnected, and the unit cannot be started up due to communication failure

3 INSTALLATION MATERIALS SELECTION

The materials, equipment and instruments used during air conditioning engineering construction must have certifications and test reports. Products with fireproof requirements must be provided with fireproof inspection certificates and must meet national and relevant compulsory standards. If environmentally-friendly materials are to be used as required by customers, all such materials must meet national environmental protection requirement and be provided with relevant certificates.

3.1 Refrigerant piping

(1) Material requirement: Dephosphorization drawing copper pipe for air conditioners;

(2) Appearance requirement: The inner and outer surface of pipe should be smooth without pinhole, crack, peeling, blister, inclusion, copper powder, carbon deposition, rust, dirt or severe oxide film, and without obvious scratch, pit, spot and other defects.

(3) Test report: Certifications and quality test reports must be provided.

(4) The tensile strength must be at least 240 kgf/mm²

(5) Specifications requirement

OD (mm)	Refrigerant	Wall Thickness (mm)	Model
6.35	R410A	0.8	0
9.52	R410A	0.8	0
12.7	R410A	0.8	0
15.88	R410A	1.0	0
19.05	R410A	1.0	0
			1/2H
22.2	R410A	1.5	1/2H

(6) After the inner part of the copper pipe is cleaned and dried, the inlet and outlet must be sealed tightly by using pipe caps, plugs or adhesive tapes.

3.2 Condensate water pipe

(1) Pipes that can be used for air conditioner drainage include: water supplying UPVC pipe, PP-R pipe, PP-C pipe, and HDG steel pipe;

(2) All relevant certificates and quality test reports are provided.

(3) Requirements for specifications and wall thickness

Water supplying UPVC pipe: $\Phi 32\text{mm} \times 2\text{mm}$, $\Phi 40\text{mm} \times 2\text{mm}$, $\Phi 50\text{mm} \times 2.5\text{mm}$;

HDG steel pipe: $\Phi 25\text{mm} \times 3.25\text{mm}$, $\Phi 32\text{mm} \times 3.25\text{mm}$, $\Phi 40\text{mm} \times 3.5\text{mm}$, $\Phi 50\text{mm} \times 3.5\text{mm}$.

3.3 Insulation material

(1) Rubber foam insulation material;

(2) Flame retardancy level: B1 or higher; Refractoriness: at least 120°C.

- (3) The insulation thickness of condensate water pipe: at least 10 mm;
- (4) When the diameter of copper pipe is equal to or greater than $\Phi 15.9$ mm, the thickness of insulation material should be at least 20mm; when the diameter of copper pipe is less than 15.9 mm, the thickness of insulation material should be at least 15 mm.

3.4 Communication cable and control cable

Note:

For air conditioning units installed in places with strong electromagnetic interference, shielded wire must be used as the communication cables of the IDU and wired controller, and shielded twisted pairs must be used as the communication cables between IDUs and between the IDU and ODU.

① The communication wire between indoor unit and wire controller

Material	Length L(m)	Sectional area (mm ²)	standard	Remarks
RVV	$L \leq 250$	$\geq 2 \times 0.75$	GB/T 5023.3-2008	$L \leq 250m$

Note: The following table shows the length (L) of the communication wire between indoor unit and wire controller.

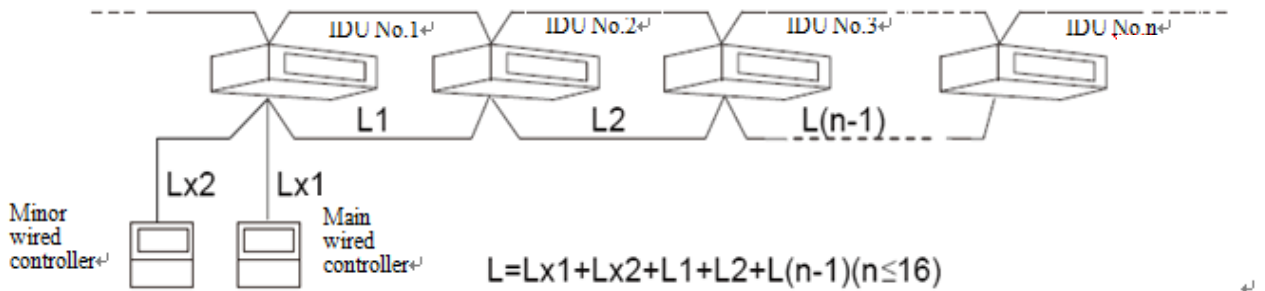

② The communication wire between indoor unit and outdoor (or indoor) unit.

Material	Length L(m)	Sectional area (mm ²)	standard	Remarks
RVV	$L \leq 1000$	$\geq 2 \times 0.75$	GB/T 5023.3-2008	If the diameter increases to $2 \times 1mm^2$, the length (L) should enlarge. But the length (L) should be less than 1500m.

Note: The following table shows the length (L) of the communication wire between indoor unit and outdoor (or indoor) unit, the sectional area of communication wire. $L = L1 + L2 + \dots + Ln$.

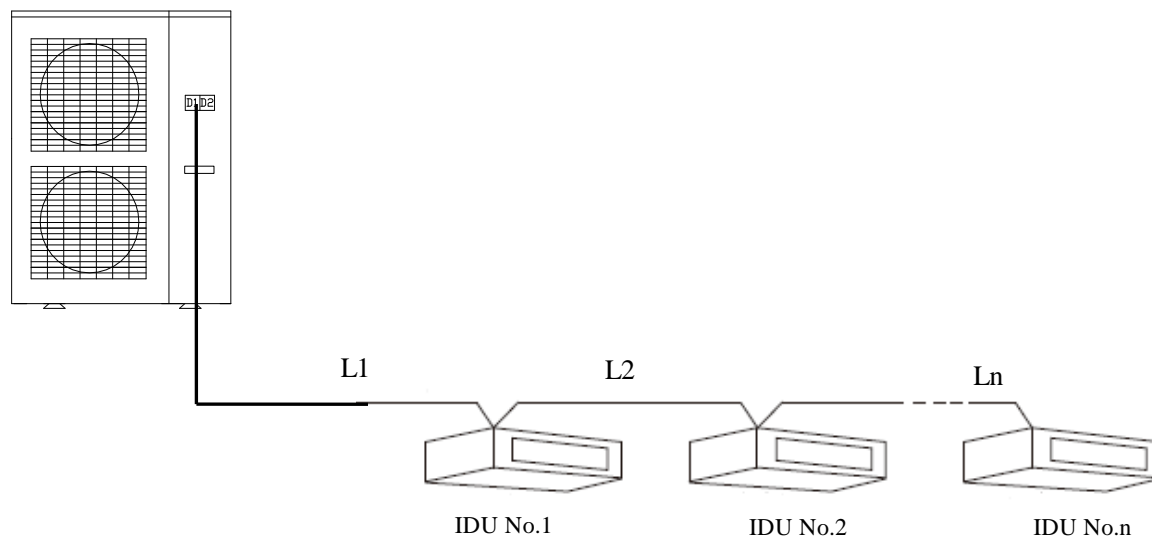

3.5 Power cable

Only copper conductors can be used as power cables. The copper conductors must meet relevant national standard and satisfy the carrying capacity of unit

① Air switch and power supply

Model	Power supply	Air switch capacity (A)	Min. sectional area of grounding wire (mm ²)	recommendable wire (sectional area mm ² × number)
GMV-224WL/A-X	380V 3N~50/60Hz	20	4.0	4.0×5
GMV-250WL/A-X	380V 3N~50/60Hz	25	4.0	4.0×5
GMV-280WL/A-X	380V 3N~50/60Hz	25	4.0	4.0×5

② Breaker capacity and power cord specification for every indoor unit.

Indoor unit	Capacity of circuit breaker (A)	Min. sectional area of grounding wire (mm ²)	Min. sectional area of power cord (mm ²)
Wall-mounted type	6	1.0	1.0
Duct type unit (heat pump)	6	1.0	1.0
Cassette type unit (heat pump)	6	1.0	1.0
One-way cassette type unit	6	1.0	1.0

If indoor unit is equipped with auxiliary electric heater, select capacity of circuit breaker as per auxiliary electric heater, which requires special setting.

Indoor unit models (with auxiliary electric heater)	Capacity of circuit breaker (A)	Min. sectional area of grounding wire (mm ²)	Min. sectional area of power cord (mm ²)
22、25、28、32、36 duct type unit	6	1.0	1.0



40、45、50 duct type unit	10	1.0	1.0
56、63、71、80 duct type unit	16	1.5	1.5
90、100、112、125、140duct type unit	10	1.0	1.0
28、36、45、50 cassette type unit	6	1.0	1.0
56、63、71 cassette type unit	10	1.0	1.0
80、90、112、125、140 cassette type unit	10	1.0	1.0

3.6 Hanger rod and support

- (1) Hanger rod: M8 or M10;
- (2) U-steel: 14# or above;
- (3) Angle steel: 30mm×30mm×3mm or above;
- (4) Round steel: Φ10mm or above

4 INSTALLATION OF OUTDOOR UNIT

4.1 Check before installation

- (1) Before installation, please check the power cord if it complies with the power supply requirement on the nameplate. Make sure the power supply is safe.
- (2) This air conditioner must be properly grounded through the receptacle to avoid electric shock. The ground wire shouldn't be connected with gas pipe, water pipe, lightning arrester or telephone line.
- (3) Maintain good air circulation to avoid lacking oxygen.
- (4) Read this manual carefully before installation.

4.2 Selection of installation site

- (1) Select a location which is strong enough to hold unit's weight so that unit can stand still and erect.
- (2) Make sure the unit is not exposed to sun and rain. And the location can resist dust, typhoon and earthquake.
- (3) Please keep the unit away from inflammable, explosive and corrosive gas or waste gas.
- (4) Make sure the location has space for heat exchange and maintenance so that unit can operate reliably with good ventilation.
- (5) ODU and IDU should stay as close as possible to shorten the length of refrigerant pipe and reduce bend angles.
- (6) Select a location which is out of children's reach. Keep the unit away from children.

4.3 Carrying and installing outdoor unit

When carrying the outdoor unit, hang the unit in four directions with two sufficient ropes. In order to avoid excursion from the center, the angel of ropes must be smaller than 40 °during hanging and moving.

4.4 Installation notices

- ◇ In order to ensure proper operation, the selection of installation site must conform to the following principle:

- ✧ The discharged air of outdoor unit will not flow back and there is sufficient space around the unit for maintenance;
- ✧ The installation site must be well ventilated to ensure sufficient air intake and discharge. Make sure there is no obstacle at the air inlet and air outlet. If there is any obstacle, please remove it;
- ✧ The installation site shall be able to withstand the weight of outdoor unit and capable for soundproof and vibration. The air outlet and noise of unit will not affect neighbors;
- ✧ The hanging of outdoor unit must use appointed hanging hole. Pay attention to protect the unit during hanging and installation.
- ✧ Prohibit hitting the sheet metal to avoid rust in the future.
- ✧ Avoid direct sunlight;
- ✧ The rain and condensation water can be drained out smoothly;
- ✧ The outdoor unit will not be embedded by the snow and not affected by garbage and oil smog;
- ✧ The installation of outdoor unit shall adopt rubber damping pad or spring damper to reduce noise and vibration;
- ✧ The installation dimension shall accord with the installation requirement of this manual and the outdoor unit must be fixed at the installation site;
- ✧ The installation shall be done by professional technicians

4.5 Fixing and damping of unit

The outdoor unit shall be fixed with 4 M12 bolts and closely contacted with the foundation. Otherwise, big vibration and noise will be caused.

The outdoor unit shall be fixed firmly. The rubber board with thickness over 20mm or corrugated rubber damping pad shall be applied between the unit and foundation.

4.6 Physical Dimension of the Outdoor Unit and Mounting Hole

GMV-224WL/A-X, GMV-250WL/A-X, GMV-280WL/A-X,

1) Outdoor unit physical dimension (mm)

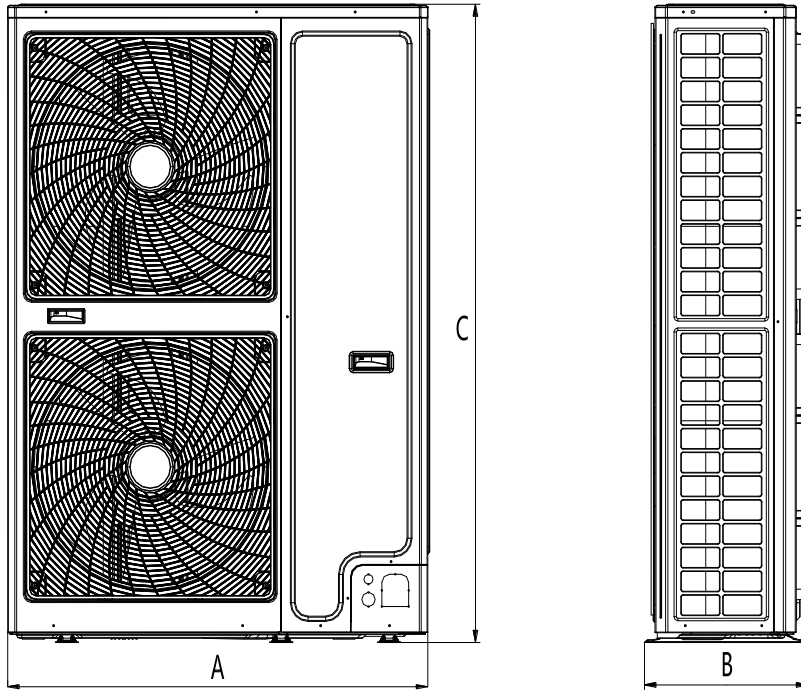

Model	A	B	C
GMV-224WL/A-X	1098	427	1584
GMV-250WL/A-X	1098	427	1584
GMV-280WL/A-X	1098	427	1584

2) Mounting hole physical dimension (mm)

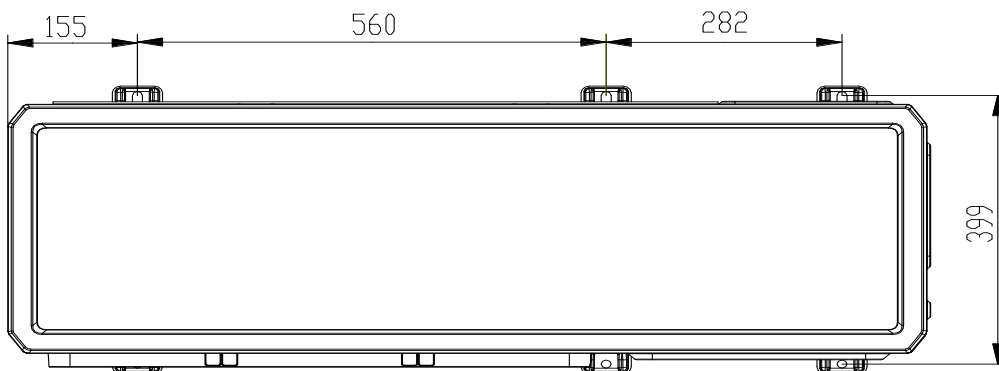

- 3) Use M12 bolt to fix up the chassis of the units when installing units.
- 4) A space is needed to install outdoor unit to insure unit operate normally.

i Obstructions in the air inlet

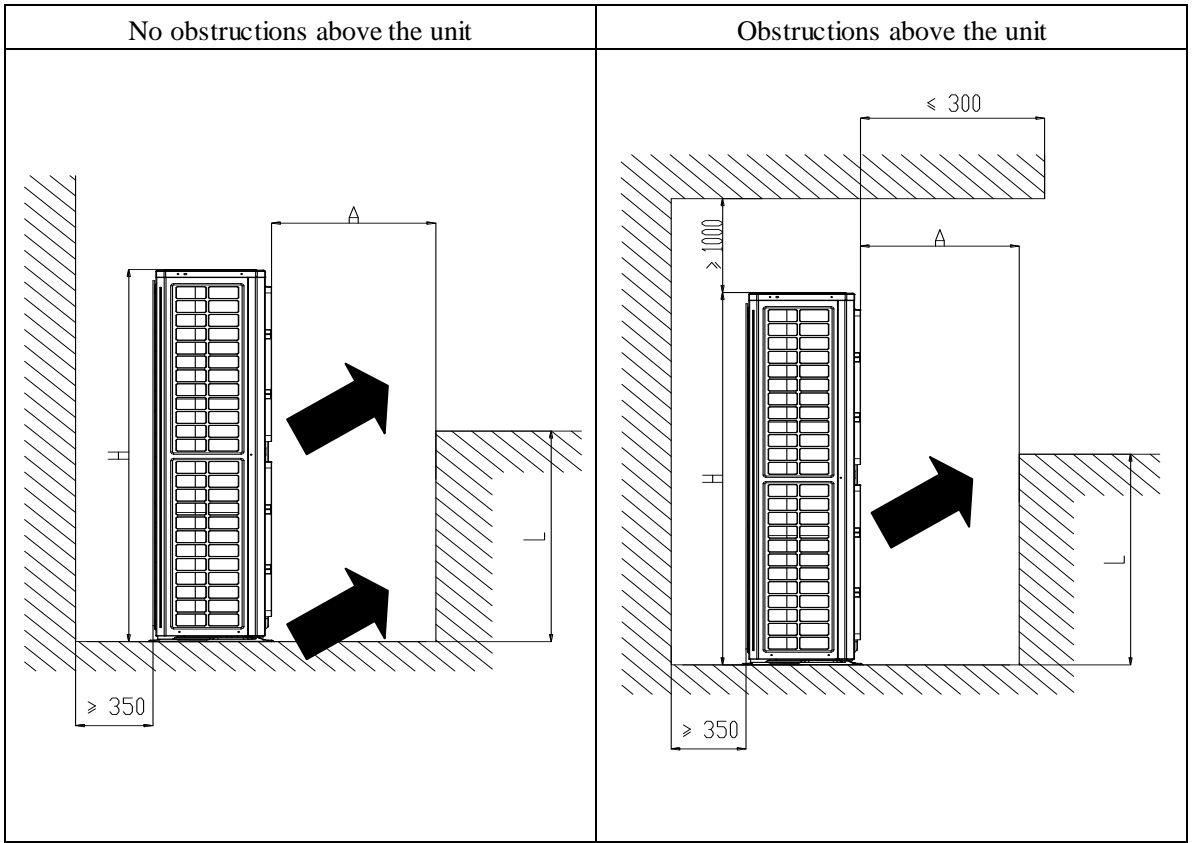

ii Obstructions in the air outlet

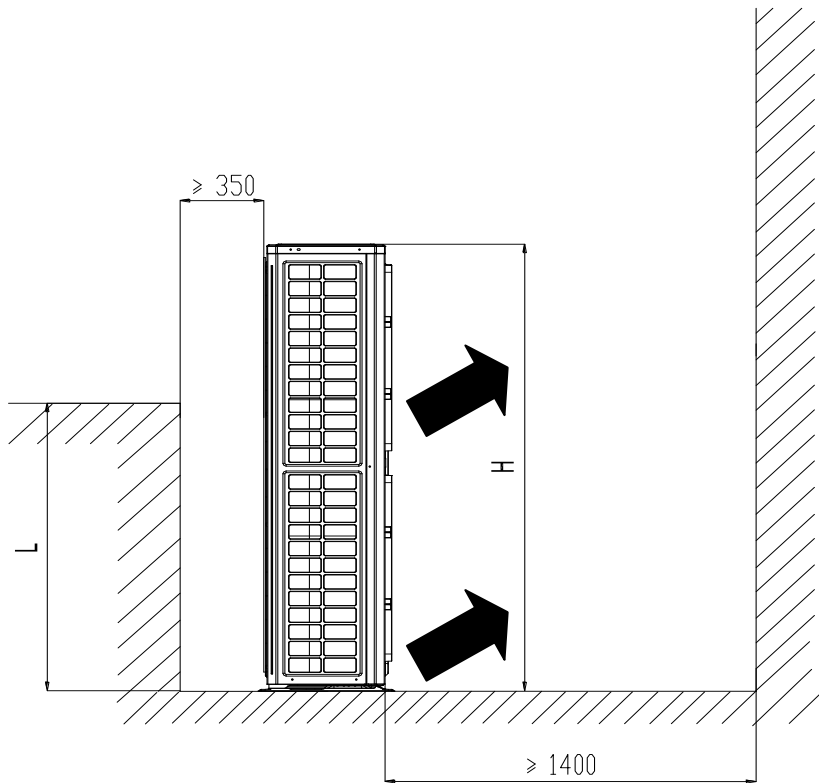

Note:

- (1) Be sure that L is less than H, and H is the height of the unit and its chassis;
- (2) The value of A must meet the following standard: (mm)

L	A
$0 < L < 1/2H$	≥ 600
$1/2H < L < H$	≥ 1400

5) Outdoor unit should be installed on the beton chassis of 10cm thickness.

5 INSTALLATION OF INDOOR UNIT

5.1 Installation of cassette type indoor unit

5.1.1 4-way cassette type

Outline and installation dimension: (mm)

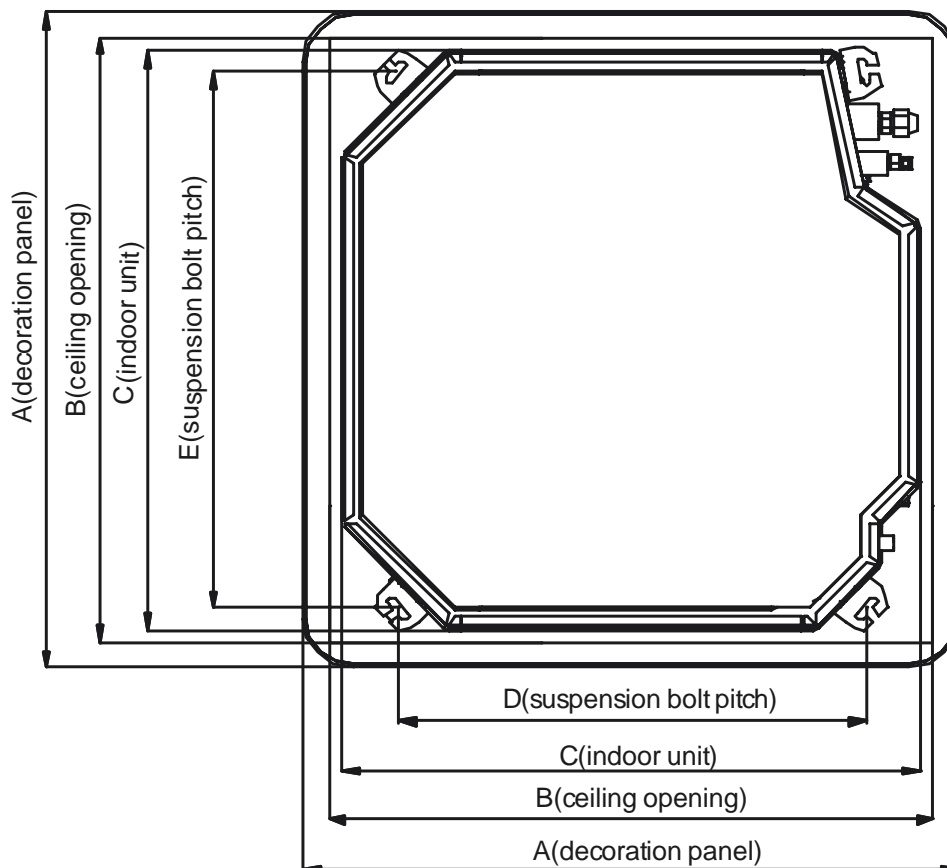

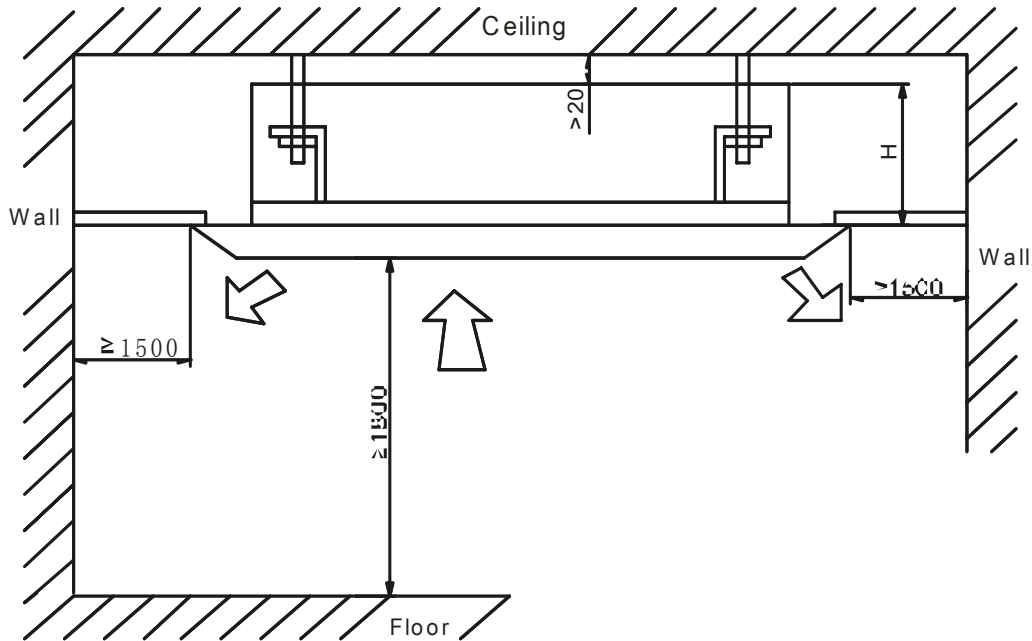

GMV-ND28T/A-T, GMV-ND36T/A-T, GMV-ND45T/A-T, GMV-ND50T/A-T (mm)

A	B	C	D	E	G	H
950	890	840	680	780	65	210

GMV-ND56T/A-T, GMV-ND63T/A-T, GMV-ND71T/A-T, GMV-ND80T/A-T (mm)

A	B	C	D	E	G	H
950	890	840	680	780	65	260

GMV-ND90T/A-T, GMV-ND100T/A-T, GMV-ND112T/A-T, GMV-ND125T/A-T, GMV-ND140T/A-T (mm)

A	B	C	D	E	G	H
950	890	840	680	780	65	340

GMV-ND160T/A-T (mm)

A	B	C	D	E	G	H
1040	975	910	787	840	65	315

5.1.2 1-way cassette type

- ① Outline dimension: (mm)

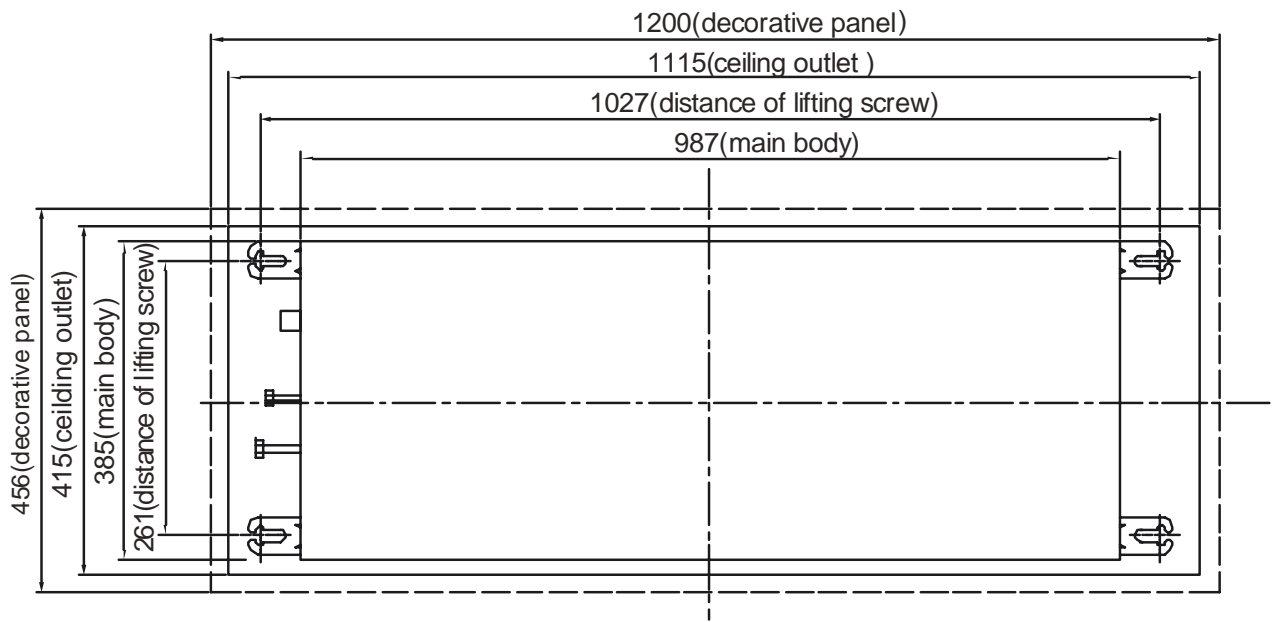

② Installation dimensions: (mm)

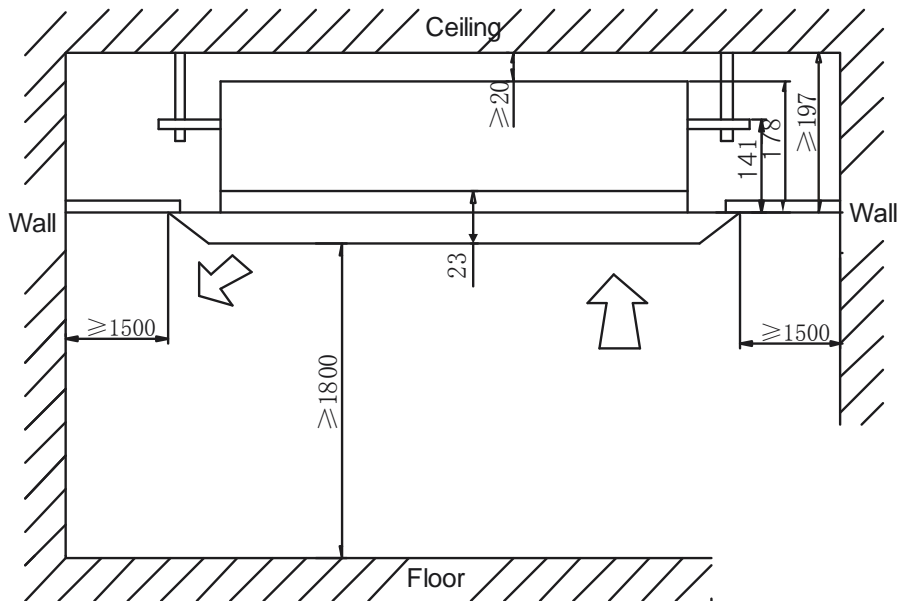

5.2 Installation of duct type indoor unit

5.2.1 Low static pressure duct type

① Outline dimensions

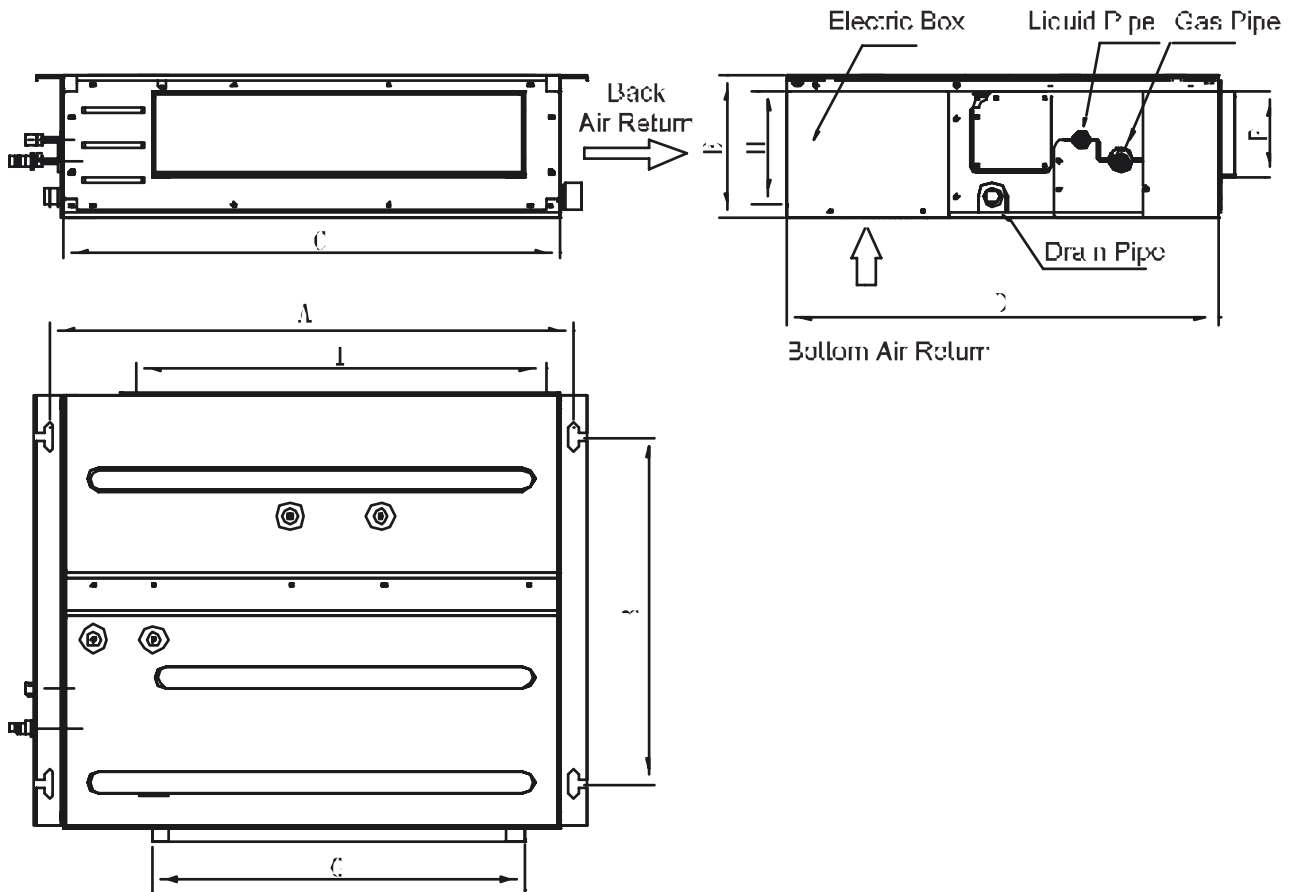

GMV-ND22PLS/A-T, GMV-ND25PLS/A-T, GMV-ND28PLS/A-T, GMV-ND32PLS/A-T, GMV-ND36PLS/A-T
(mm)

A	B	C	D	E	F	G	H	I
742	491	700	615	200	121	528	161	580

GMV-ND40PLS/A-T, GMV-ND45PLS/A-T, GMV-ND50PLS/A-T (mm)

A	B	C	D	E	F	G	H	I
942	491	900	615	200	121	728	161	780

GMV-ND56PLS/A-T, GMV-ND63PLS/A-T (mm)

A	B	C	D	E	F	G	H	I
1142	491	1100	615	200	121	928	161	980

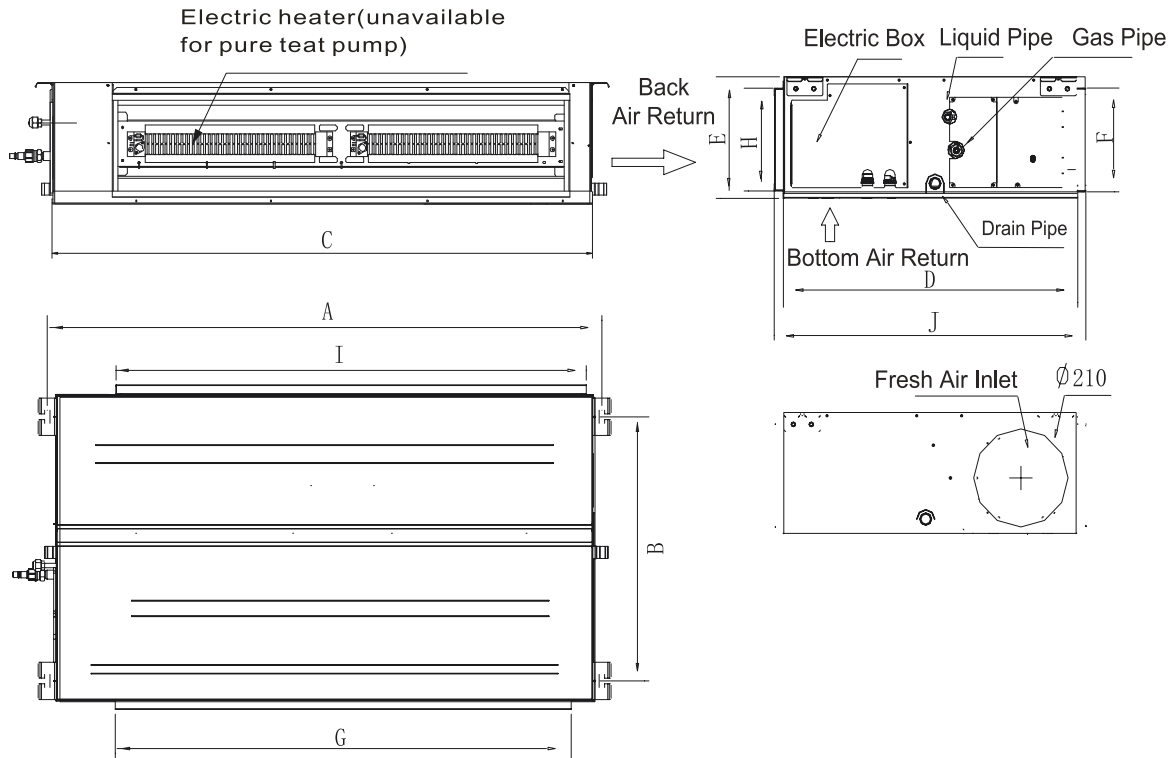

GMV-ND71PLS/A-T, GMV-ND80PLS/A-T (mm)

A	B	C	D	E	F	G	H	I	J
1236	565	1200	655	260	222	1016	220	1050	695

GMV-ND90PLS/A-T, GMV-ND100PLS/A-T, GMV-ND112PLS/A-T, GMV-ND125PLS/A-T, GMV-ND140PLS/A-T (mm)

A	B	C	D	E	F	G	H	I	J
1379	565	1340	655	260	207	1153	220	1188	716

② Installation space: (mm)

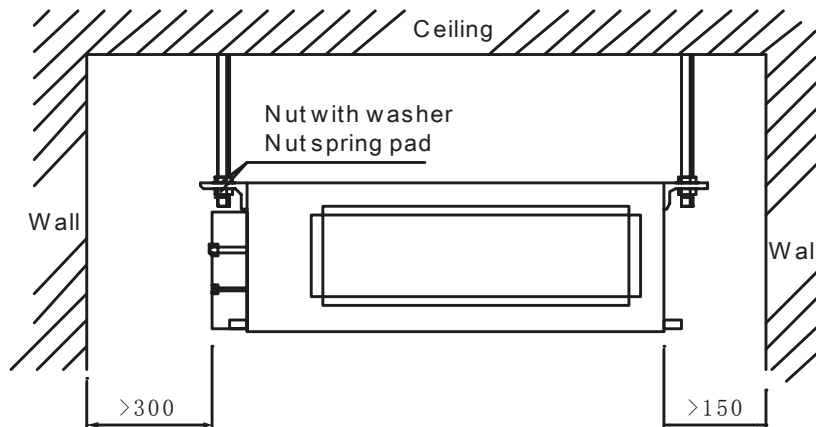

5.2.2 Slim duct type

① Outline Dimensions:

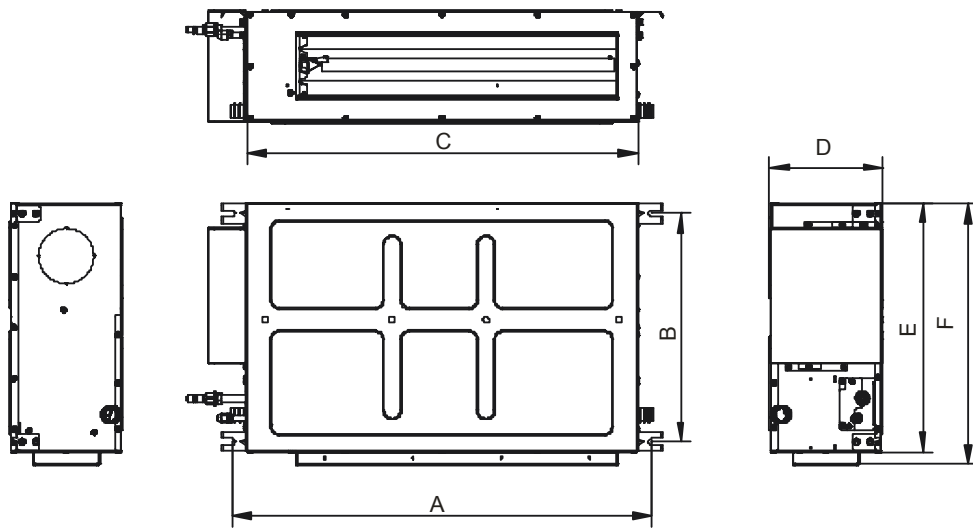

GMV-ND22PL/B-T, GMV-ND25PL/B-T, GMV-ND28PL/B-T, GMV-ND32PL/B-T, GMV-ND36PL/B-T (mm)

A	B	C	D	E	F
760	415	710	200	450	475

GMV-ND40PL/B-T, GMV-ND45PL/B-T, GMV-ND50PL/B-T, GMV-ND56PL/B-T, GMV-ND63PL/B-T (mm)

A	B	C	D	E	F
1060	415	710	200	450	475

GMV-ND72PL/B-T (mm)

A	B	C	D	E	F
1360	415	1310	200	450	475

② Space Dimension for Installation: (mm)

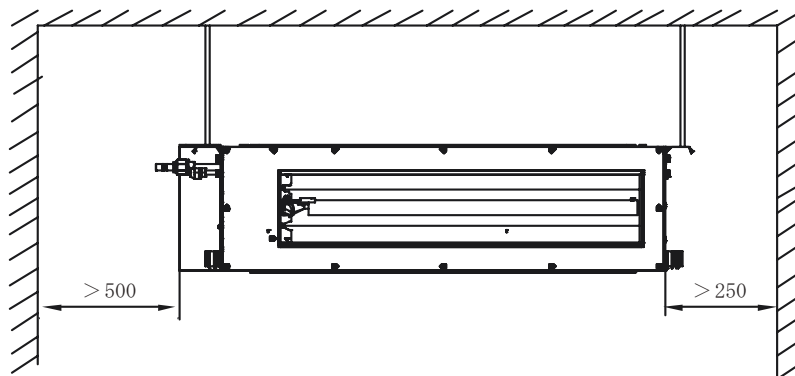

5.2.3 High static pressure duct type

① Outline Dimensions:

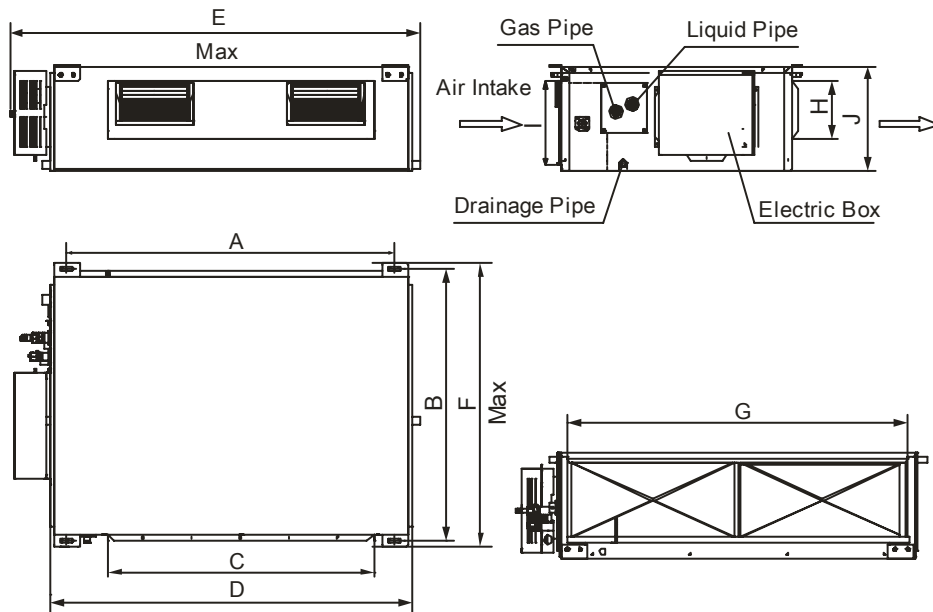

GMV-ND56PHS/A-T, GMV-ND63PHS/A-T, GMV-ND71PHS/A-T, GMV-ND80PHS/A-T (mm)

A	B	C	D	E	F	G	H	I	J
1101	517	820	1159	1271	558	1002	160	235	268

GMV-ND90PHS/A-T, GMV-ND100PHS/A-T, GMV-ND112PHS/A-T, GMV-ND125PHS/A-T, GMV-ND140PHS/A-T (mm)

A	B	C	D	E	F	G	H	I	J
1101	748	820	1115	1229	775	979	160	231	290

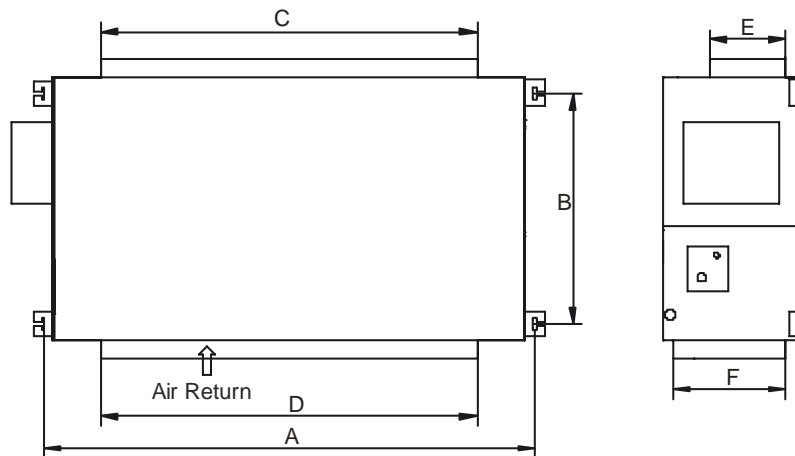

GMV-ND224PH/A-T (mm)

A	B	C	D	E	F
1353	632	992	1150	192	327

GMV-ND280PH/A-T (mm)

A	B	C	D	E	F
1563	706	992	1350	192	402

② Space Dimension for Installation: (mm)

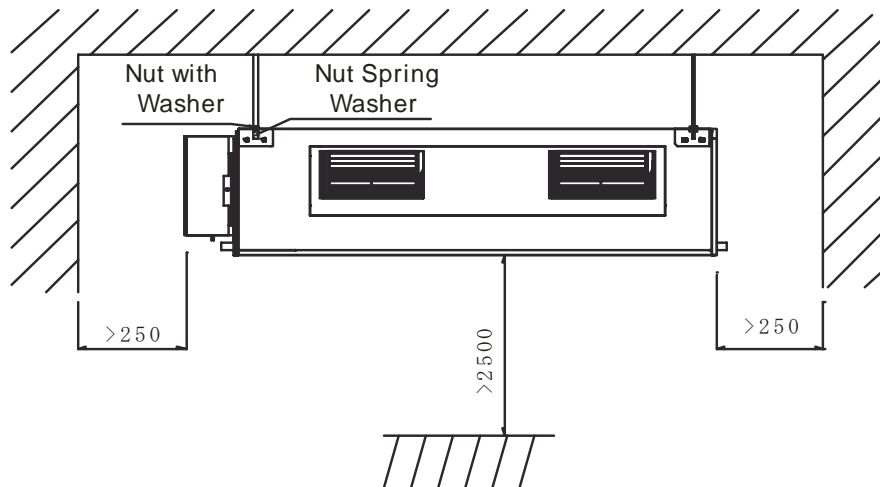

5.3 Installation of floor ceiling type indoor unit

① Outline Dimensions:

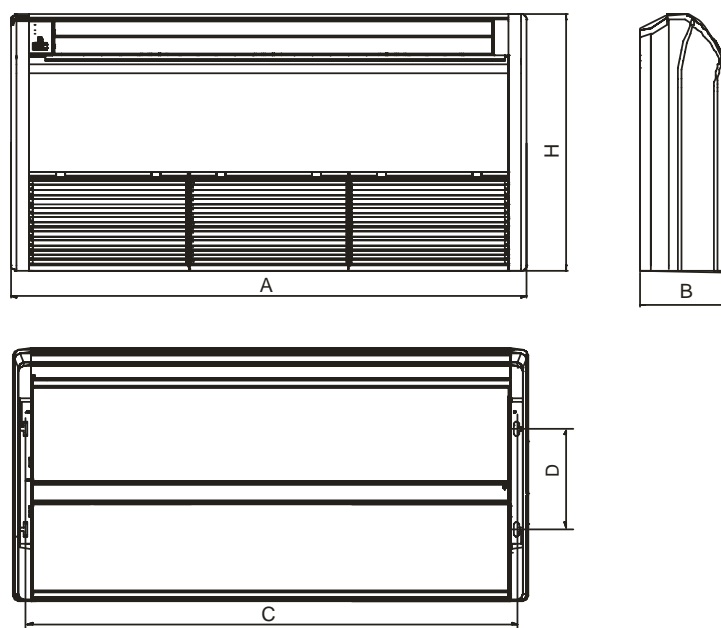



GMV-ND28ZD/A-T, GMV-ND36ZD/A-T, GMV-ND50ZD/A-T, GMV-ND56ZD/A-T (mm)

A	B	C	D	H
1220	225	1158	280	700

GMV-ND63ZD/A-T, GMV-ND71ZD/A-T, GMV-ND90ZD/A-T (mm)

A	B	C	D	H
1420	245	1354	280	700

GMV-ND112ZD/A-T, GMV-ND125ZD/A-T, GMV-ND140ZD/A-T (mm)

A	B	C	D	H
1700	245	1634	280	700

② Space Dimension for Installation: (mm)

1) Floor type

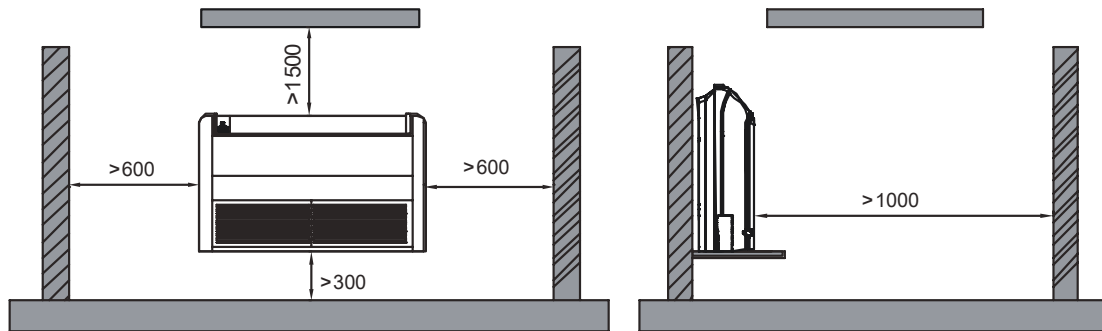

2) Ceiling type

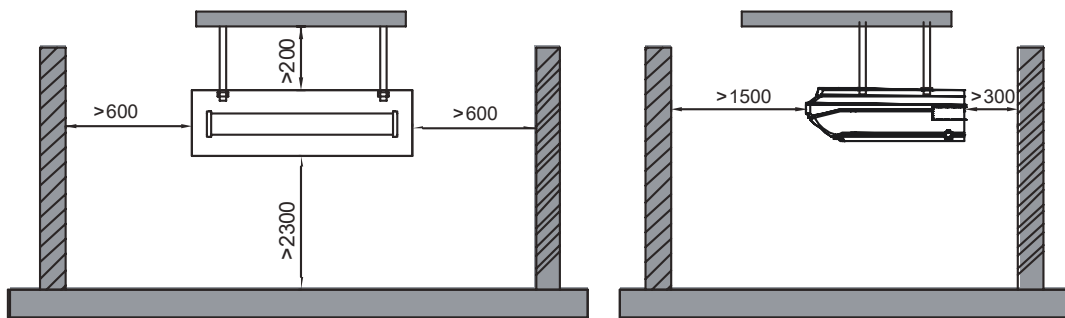

5.4 Installation of wall-mounted indoor unit

① Outline dimensions

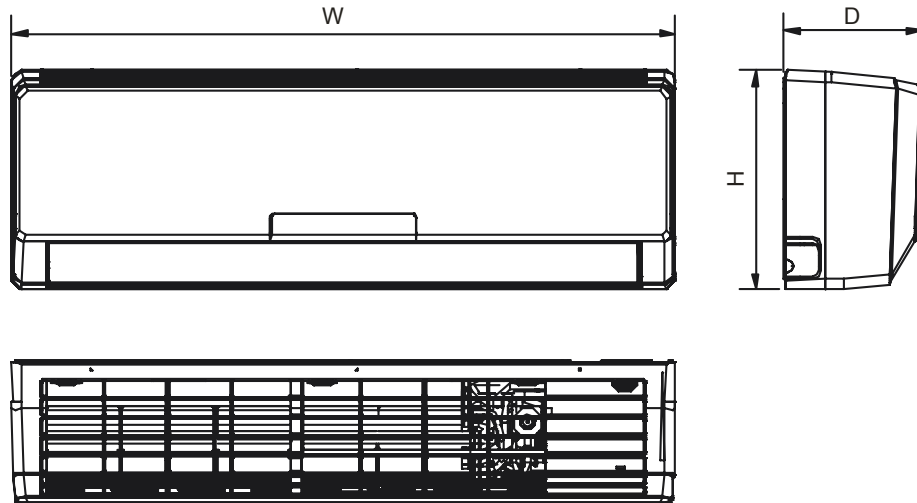

GMV-N22G/A3A-K, GMV-N28G/A3A-K (mm)

W	H	D
843	275	180

GMV-N36G/A3A-K, GMV-N45G/A3A-K, GMV-N50G/A3A-K (mm)

W	H	D
940	298	200

GMV-N56G/A3A-K, GMV-N63G/A3A-K, GMV-N71G/A3A-K (mm)

W	H	D
1008	319	221

② Installation space (mm)

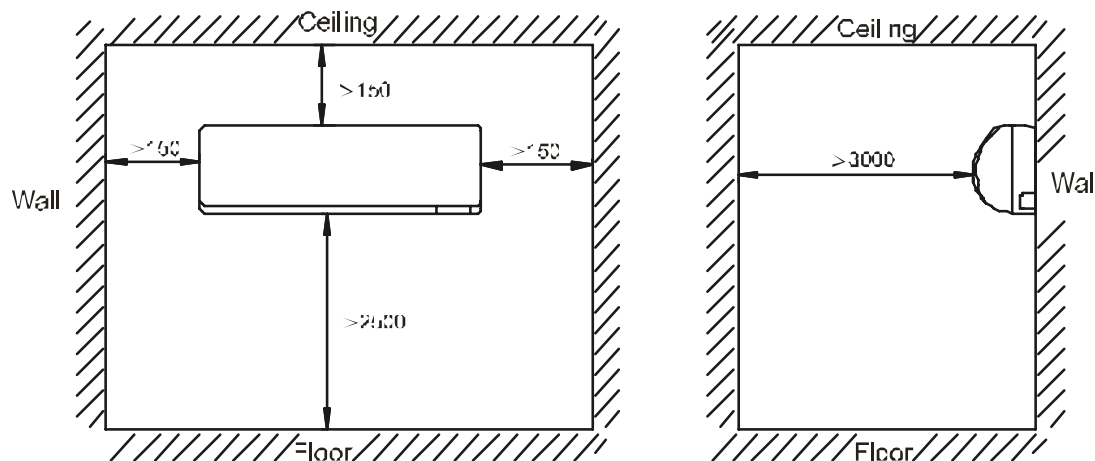

5.5 Installation notice

- (1) Installation dimension (refer to the outline dimension in the figure).
- (2) Make sure the top hanging rod, ceiling and building structure have sufficient strength to withstand the weight of

unit.

(3) Keep the unit from fire, flammable objects, corrosive gas or exhaust gas;

Please reserve ventilation space;

Please reserve sufficient space for maintenance;

Please take proper measures to reduce noise and vibration.

(4) Electrical installation of unit.

All electrical installation must be done by professionals according to national and local laws and regulations.

The unit must be grounded reliably. Please connect wire according to the wiring diagram on the unit.

6 EXCURSUS

6.1 Schedule of refrigerant characteristic

Refrigerant Characteristic	R410A	R407C	R22
Components percentage (wt%)	R32/R125 (50/50)	R32/R125/R134a (23/25/52)	R22 (100)
Boiling point (°C)	-51.4	-43.6	-40.8
State	Approximate Azeotrope	Azeotrope	-
Pressure at 54.5°C (kpa)	3406	2262	2151
Temp.Excursion (°C)	0.11	5.4	0
ODP	0	0	0.055

6.2 Installation flowchart

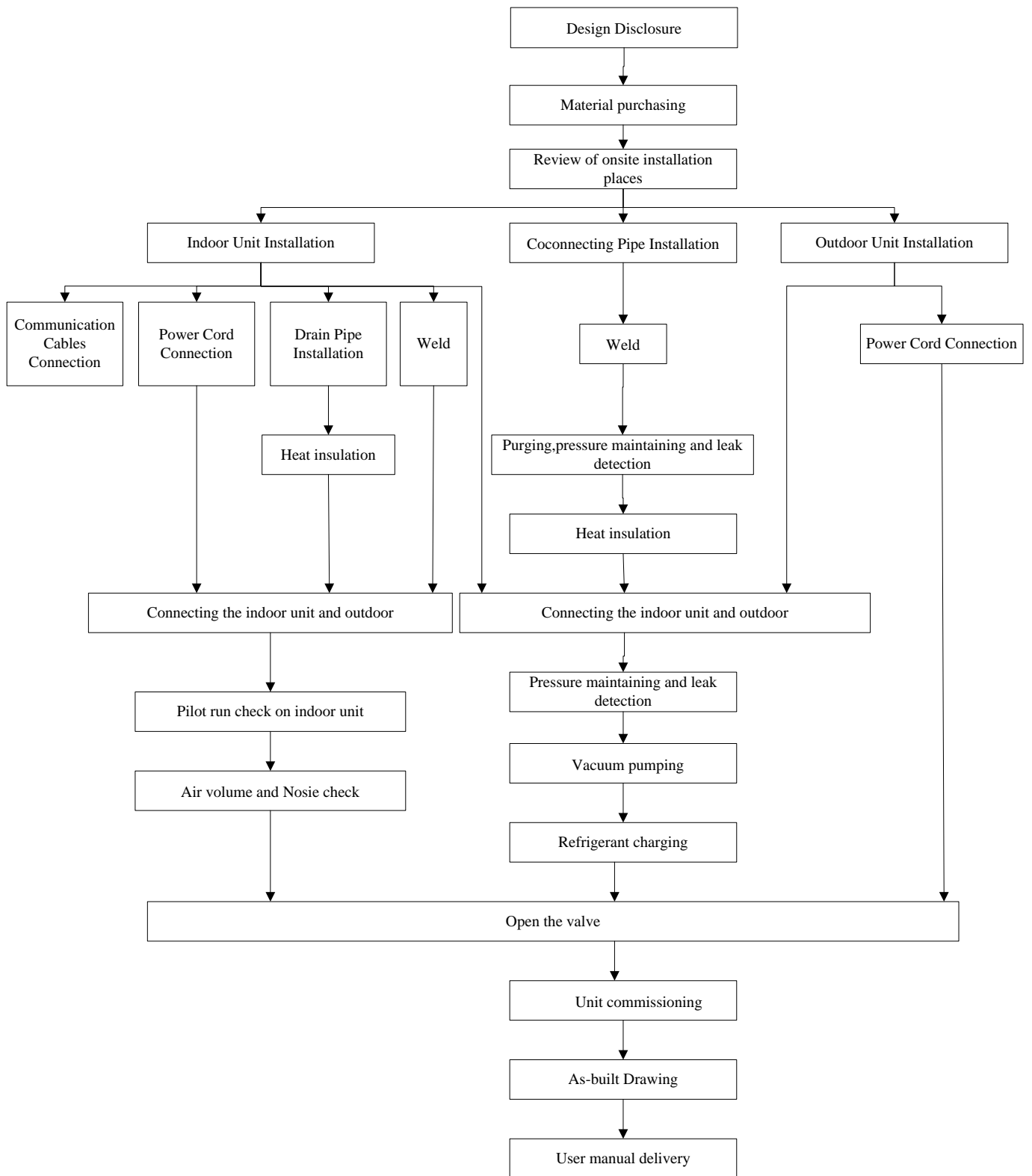



Maintenance

MAINTENANCE

1 TROUBLE TABLE**1.1 Trouble Display of Outdoor Unit**

1.1.1 Error code of protection

Error Item	Code	Indoor Unit Display	Outdoor Unit Display
Indoor fan protection	L1	L1	L1
Water overflow protection	L3	L3	L3
Anti-freeze protection	L5	L5	L5
Mode conflict	L6	L6	L6
Malfunction of indoor ambient temperature sensor	d3	d3	d3
Malfunction of indoor coil inlet temperature sensor	d4	d4	d4
Malfunction of indoor mid-coil temperature sensor	d5	d5	d5
Malfunction of indoor coil outlet temperature sensor	d6	d6	d6
Malfunction of indoor humidity sensor	d7	d7	d7
Malfunction of jumper	d9	d9	d9
Malfunction of outdoor ambient temperature sensor	b1	b1	b1
Malfunction of defrosting temperature sensor	b3	b3	b3
Malfunction of outdoor condenser temperature sensor	b5	b5	b5
Malfunction of suction temperature sensor	b6	b6	b6
No master IDU	L7	L7	
High pressure protection	E1	E1	E1
Low pressure protection	E3	E3	E3
Discharge protection	E4	E4	E4
Refrigerant-lacking protection	Ed	E0	Ed
Power protection of compressor	EN	E0	EN
Malfunction of EEPROM chip	F0	F0	F0
Malfunction of high pressure sensor	F1	F1	F1
Malfunction of low pressure sensor	F3	F3	F3
Malfunction of discharge temperature sensor of compressor 1	F5	F5	F5
Malfunction of discharge temperature sensor of compressor 2	F6	F6	F6

Malfunction of high-pressure switch	Fd	E0	Fd
AC current protection	P5	P0	P5
IPM protection	P6	P0	P6
Drive IPM module protection of compressor	P7	P0	P7
Drive IPM module overheating protection of compressor	P8	P0	P8
Desynchronizing protection of inverter compressor	P9	P0	P9
High voltage protection of compressor's drive DC busbar	PH	P0	PH
Drive current detection circuit malfunction of compressor	PC	P0	PC
Low voltage protection of compressor's drive DC busbar	PL	P0	PL
Phase-lacking of inverter compressor	PE	P0	PE
Drive charging circuit malfunction of compressor	PF	P0	PF
Demagnetization protection	PU	P0	PU
Communication malfunction between indoor and outdoor units, indoor unit's wired controller	C0	C0	C0
Communication malfunction between main controller and inverter compressor driver	C2	C2	C2
Phase-lacking protection of power	U3	E0	U3
Malfunction of fan	H0	H0	H0

1.1.2 Error code of limiting frequency reduction protection

Error Item	Code	Display
Limited frequency reduction for high pressure protection	FA	Only the outdoor unit displays the code
Limited frequency reduction for low pressure protection	FH	
Limited frequency reduction for discharge temperature protection	F9	
Limited frequency reduction for AC current protection	F8	
Limited frequency reduction for power protection	FC	
Limited frequency reduction for IPM temperature protection	FL	

1.1.3 Operation code

Operation	Code	Display
Trail run	A0	Both units display the code
Fluorine recycle	A2	
Defrosting	A3	
Oil return	A4	
Testing online	A5	

Vacuumization	A8	
Test module	SS	Only the outdoor unit displays the code

Note: Last ten protection shutdown and protection limited frequency reduction can be searched through the debugging controller.

1.1.4 The meaning of indicator light flicker for mainboard and drive board.

Flicker Times	Yellow	Red	Green
1	Compressor1 ON	Outdoor unit is always at ON status	Drive board
2	Compressor2 ON	Reservation	Debug board
3	Overcurrent for IPM1	Oil return	Testing online
4	Overcurrent for IPM1	Defrosting	PC monitor
5	IPM1 protection	Limited frequency reduction for IPM temperature protection	Indoor unit 1
6	IPM2 protection	Limited frequency reduction for pfc temperature protection	Indoor unit 2
7	PFC overcurrent	Limited frequency reduction for AC current protection	Indoor unit 3
8	PFC protection	Limited frequency reduction for power protection	Indoor unit 4
9	Low voltage protection	Limited frequency reduction for discharge temperature protection	Indoor unit 5
10	High voltage protection	Limited frequency reduction for low pressure protection	Indoor unit 6
11	System low pressure protection	Limited frequency reduction for high pressure protection	Indoor unit 7
12	System high pressure protection	Malfunction of discharge temperature sensor of compressor 1	Indoor unit 8
13	High-pressure switch protection	Malfunction of outdoor ambient temperature sensor	Indoor unit 9
14	Drive charging circuit malfunction of compressor	Malfunction of outdoor tube temperature sensor	Indoor unit 10
15	AC current protection	Malfunction of suction temperature sensor	Indoor unit 11
16	Malfunction of EEPROM chip	Malfunction of indoor coil inlet temperature sensor	Indoor unit 12
17	Demagnetization protection for compressor1	Malfunction of temperature sensor for subcooler	Indoor unit 13



18	Desynchronizing protection of inverter compressor1	Malfunction of low-pressure sensor	Indoor unit 14
19	Phase-lacking of inverter compressor1	Malfunction of high-pressure sensor	Indoor unit 15
20	Malfunction of phase current testing for compressor1	Fan protection	Indoor unit 16
21	Power protection of compressor1	Malfunction of discharge temperature sensor of compressor 2	Indoor unit 17
22	Over loading for compressor2		Indoor unit 18
23	Discharge protection for compressor1		Indoor unit 19
24	Demagnetization protection for compressor2		Indoor unit 20
25	Desynchronizing protection of inverter compressor2		
26	Phase-lacking of inverter compressor2		
27	Malfunction of phase current testing for compressor1		
28	Power protection of compressor1		
29	Over loading for compressor2		
30	Discharge protection for compressor2		
31	Refrigerant-lacking protection		

Note: The flicker times of driveboard are equal to that of mainboard, and its malfunction is also the same.

2 FLOW CHART OF TROUBLE SHOOTING

2.1 Communication Error between the Compressor Drive Board and the Main Control Board

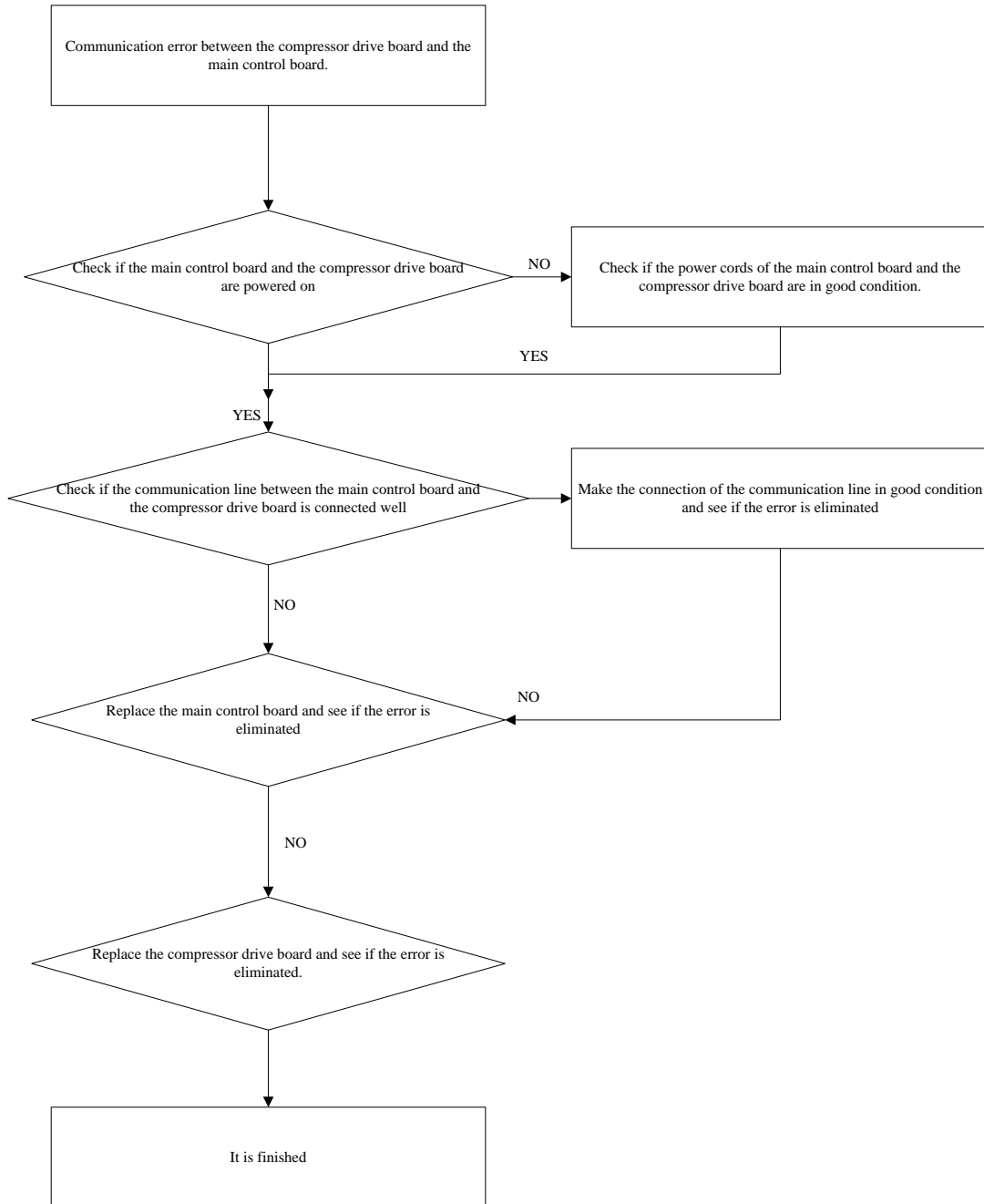

2.2 High-Pressure Protection

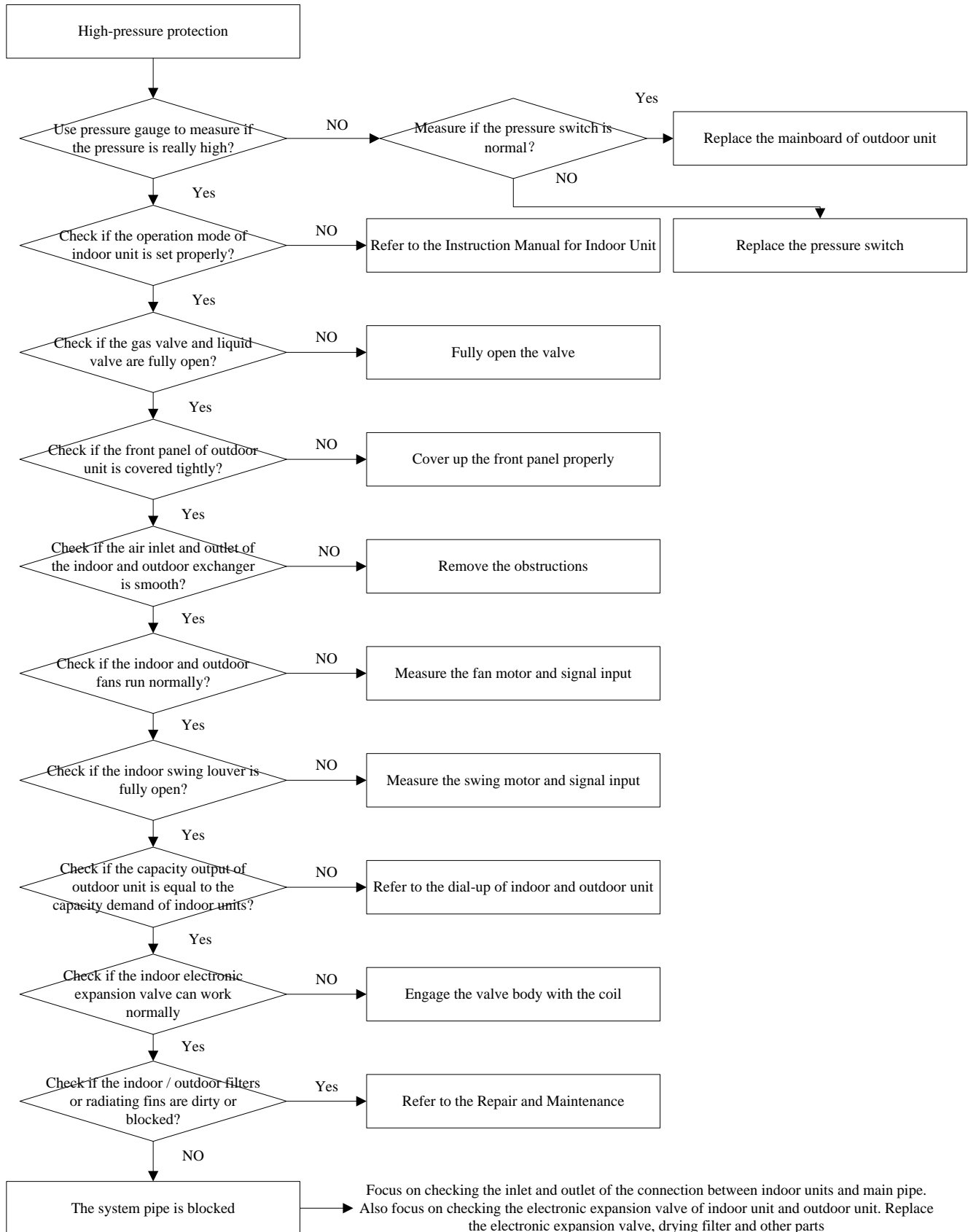

2.3 Low-Pressure Protection

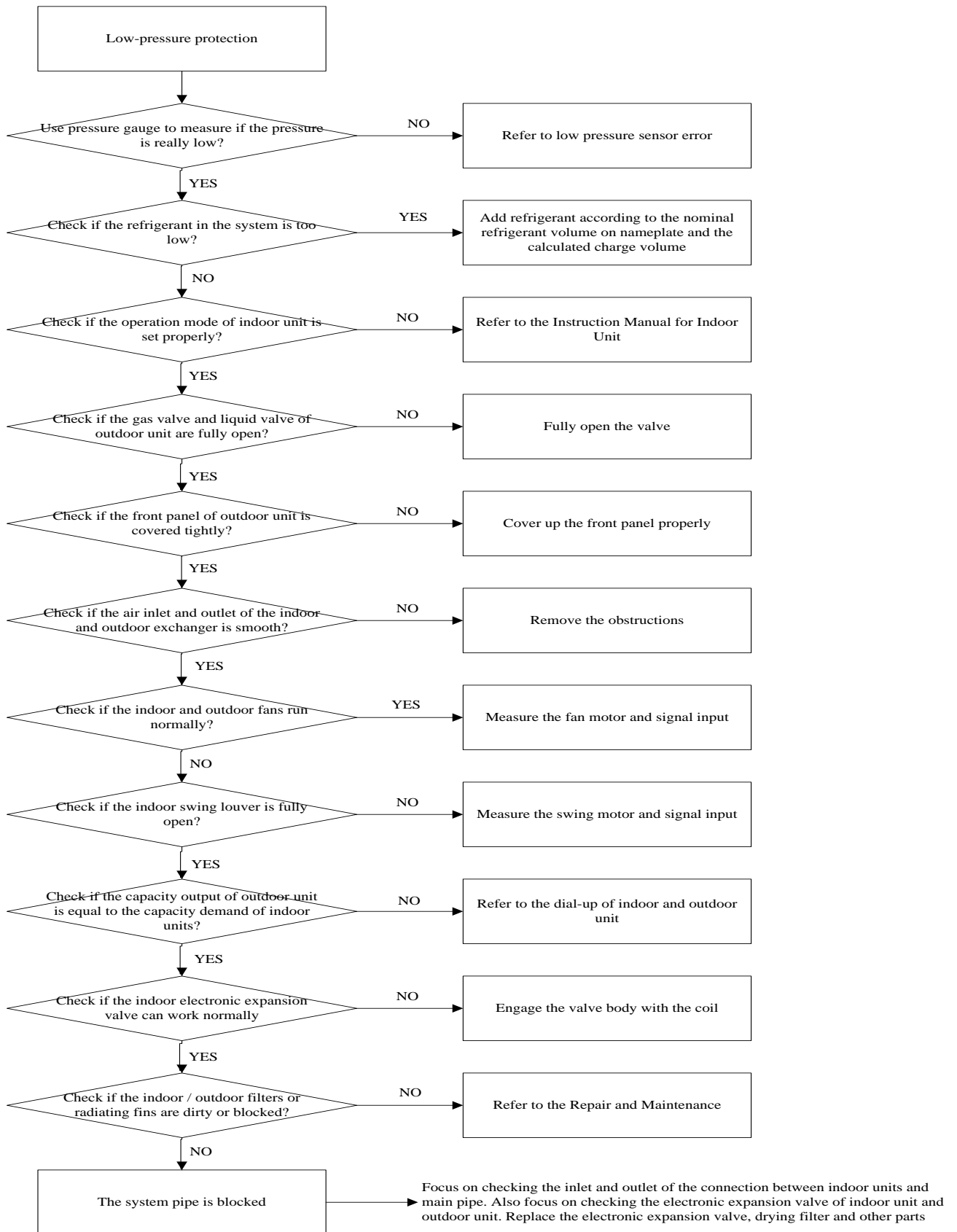

2.4 Exhaust Temperature Protection

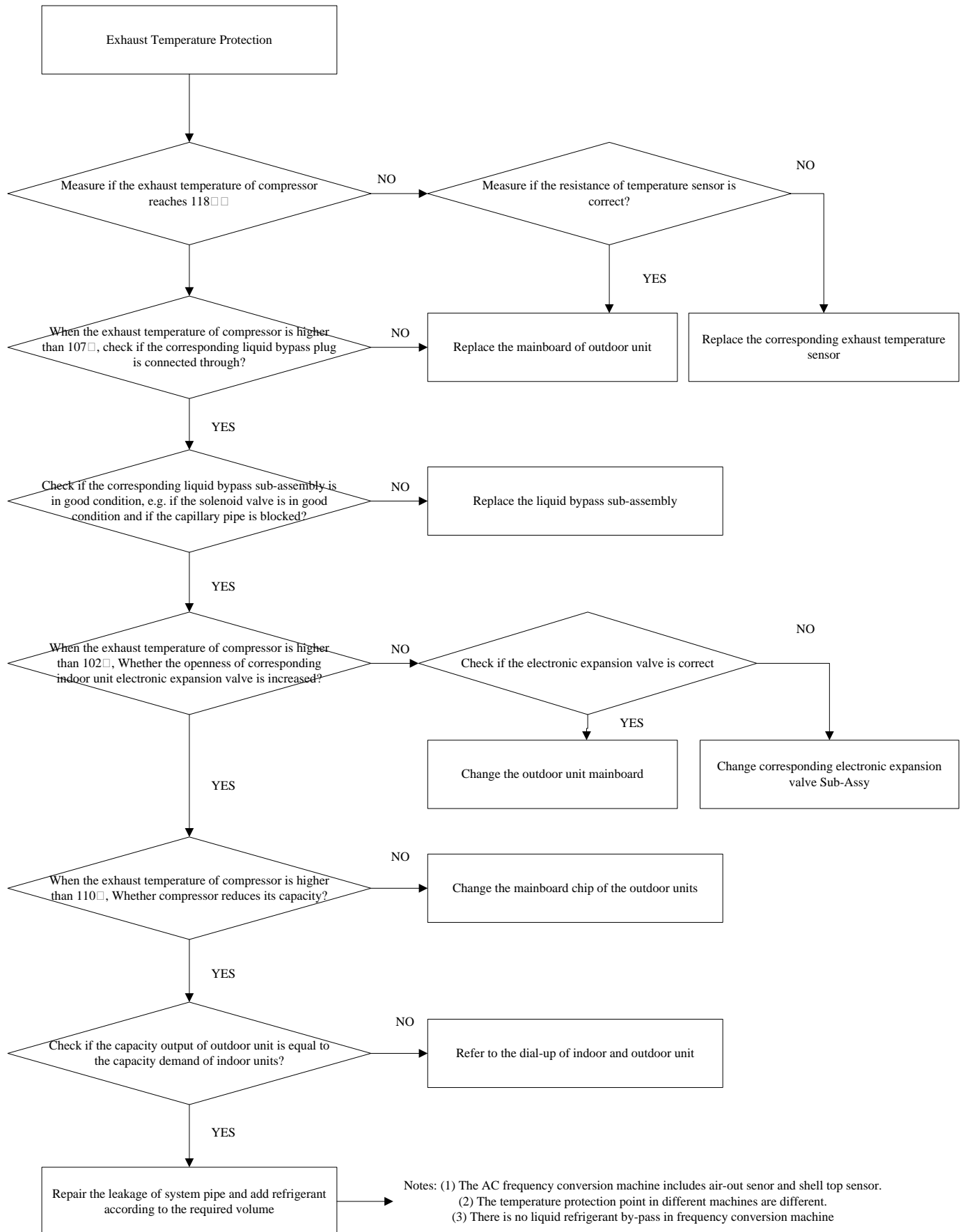

2.5 Refrigerant Protection

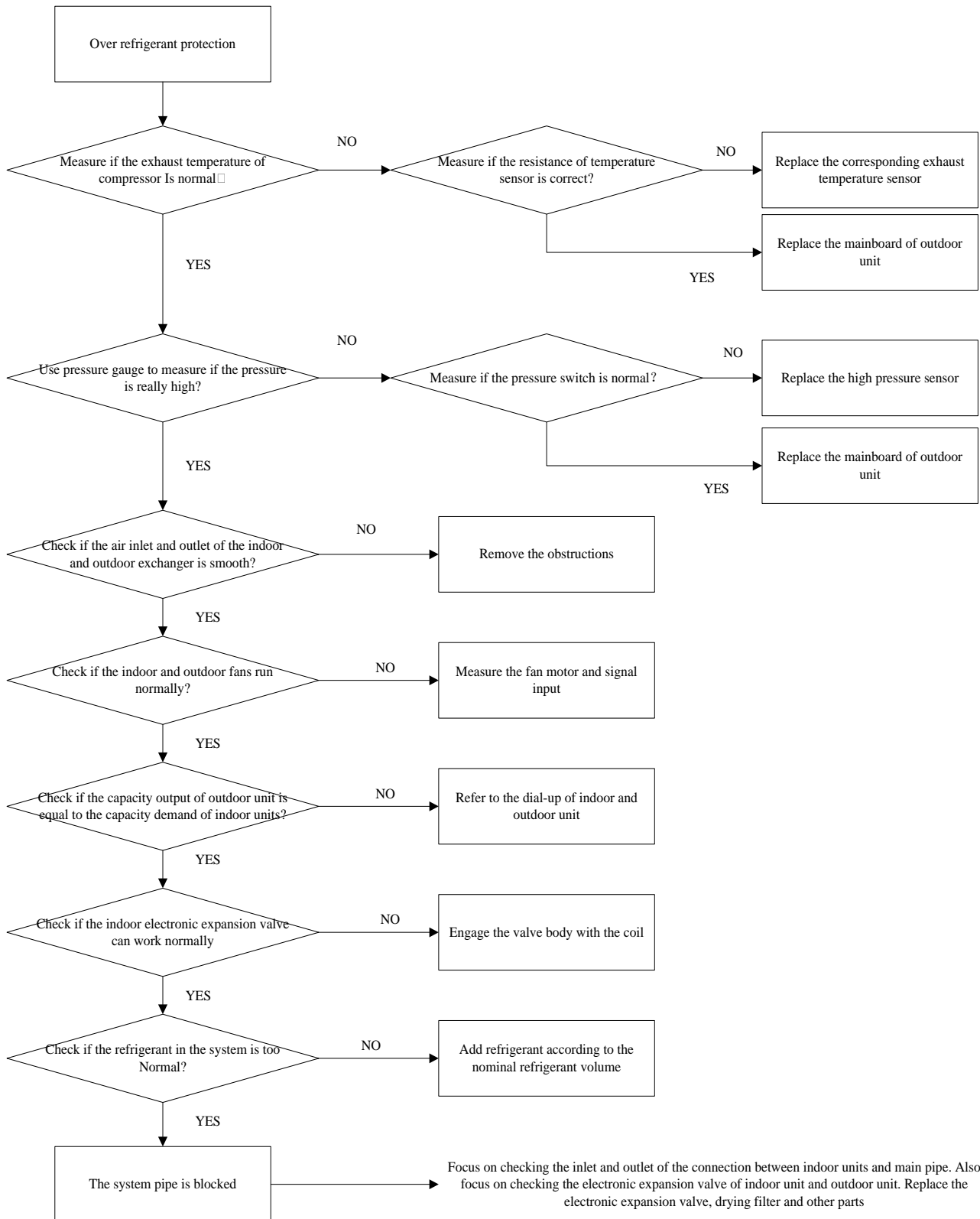



2.6 Communication malfunction

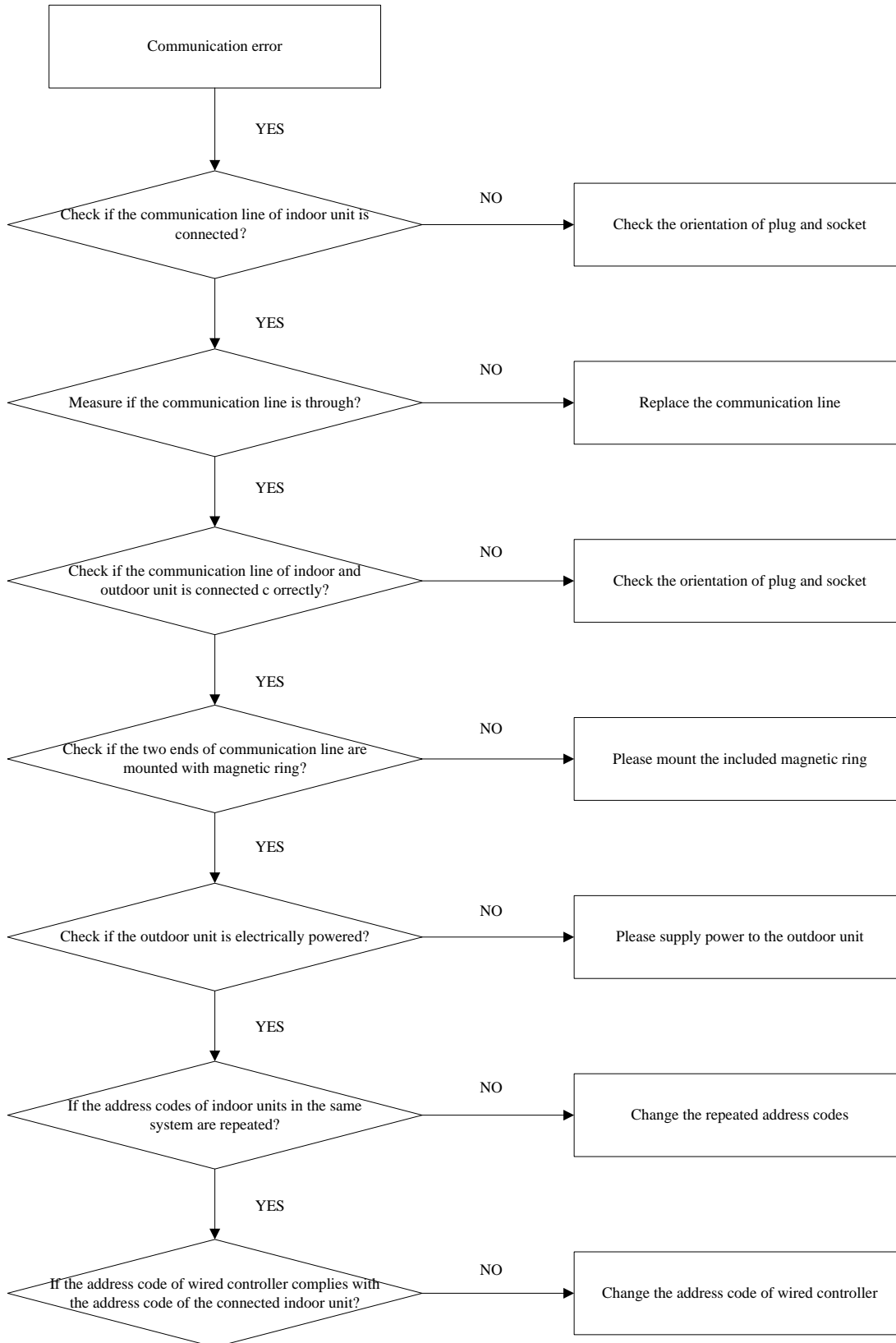

2.7 Water-full Protection

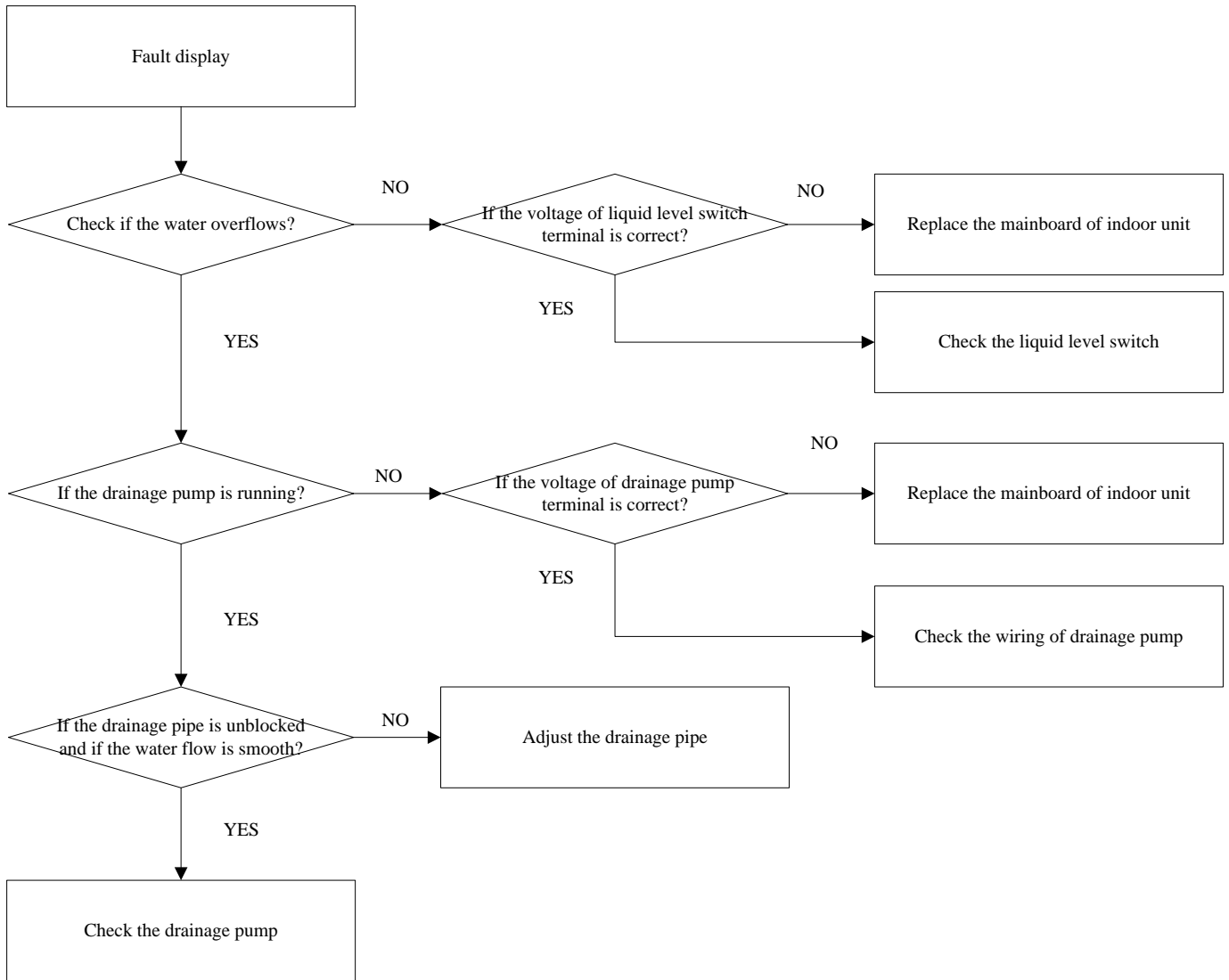



2.8 Temperature Sensor Error

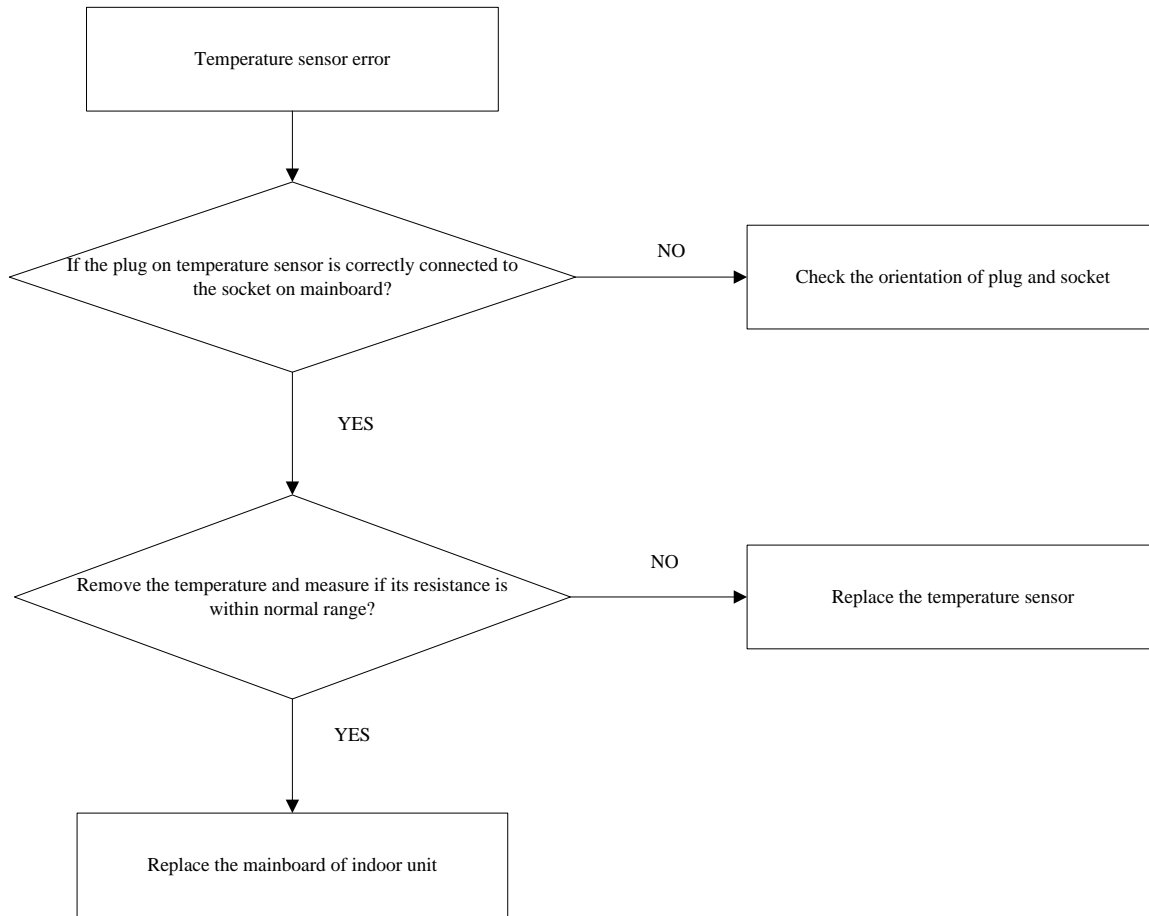

2.9 High/Low-Pressure Sensor Error

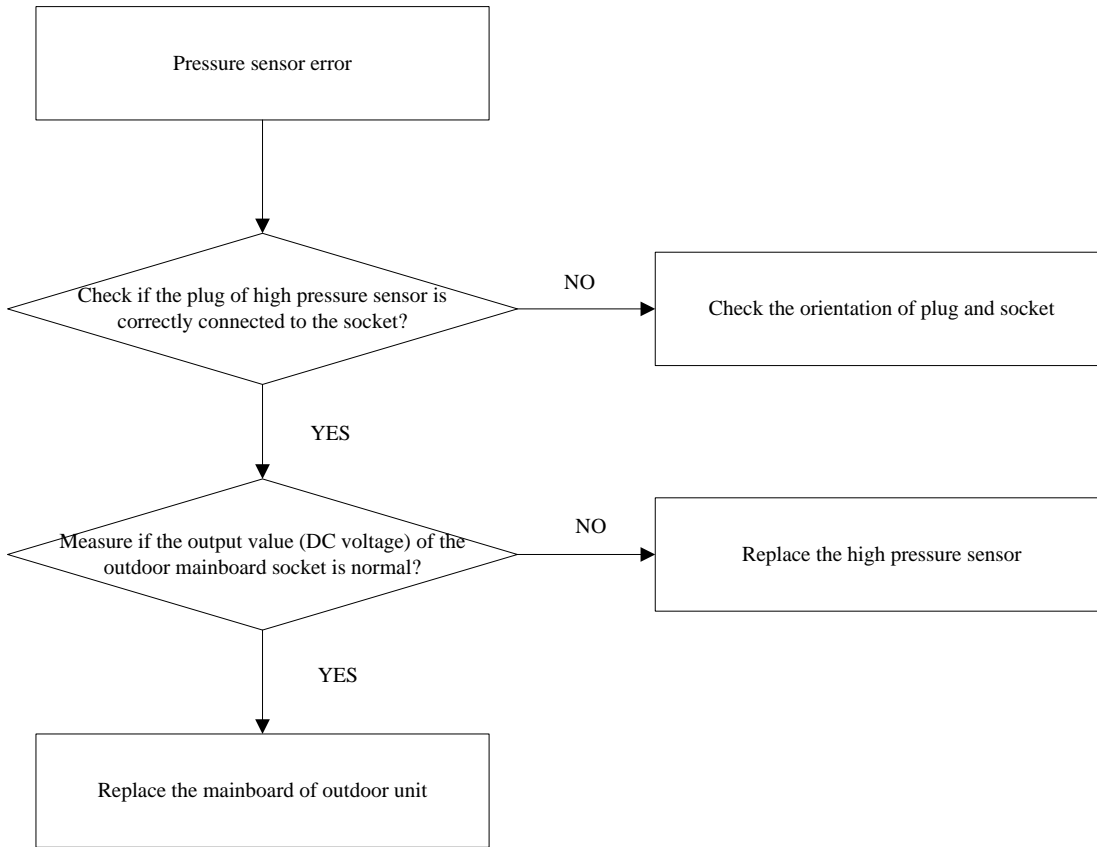

2.10 IPM temperature sensor error

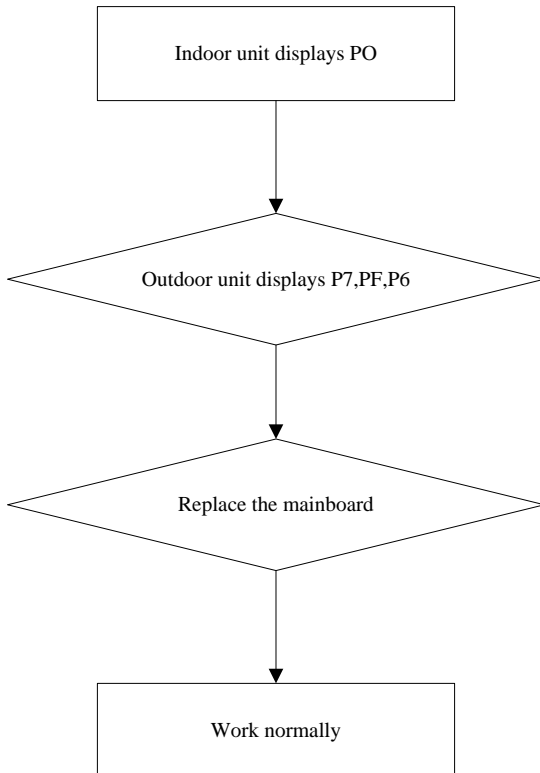



2.11 No energization to the unit and mainboard

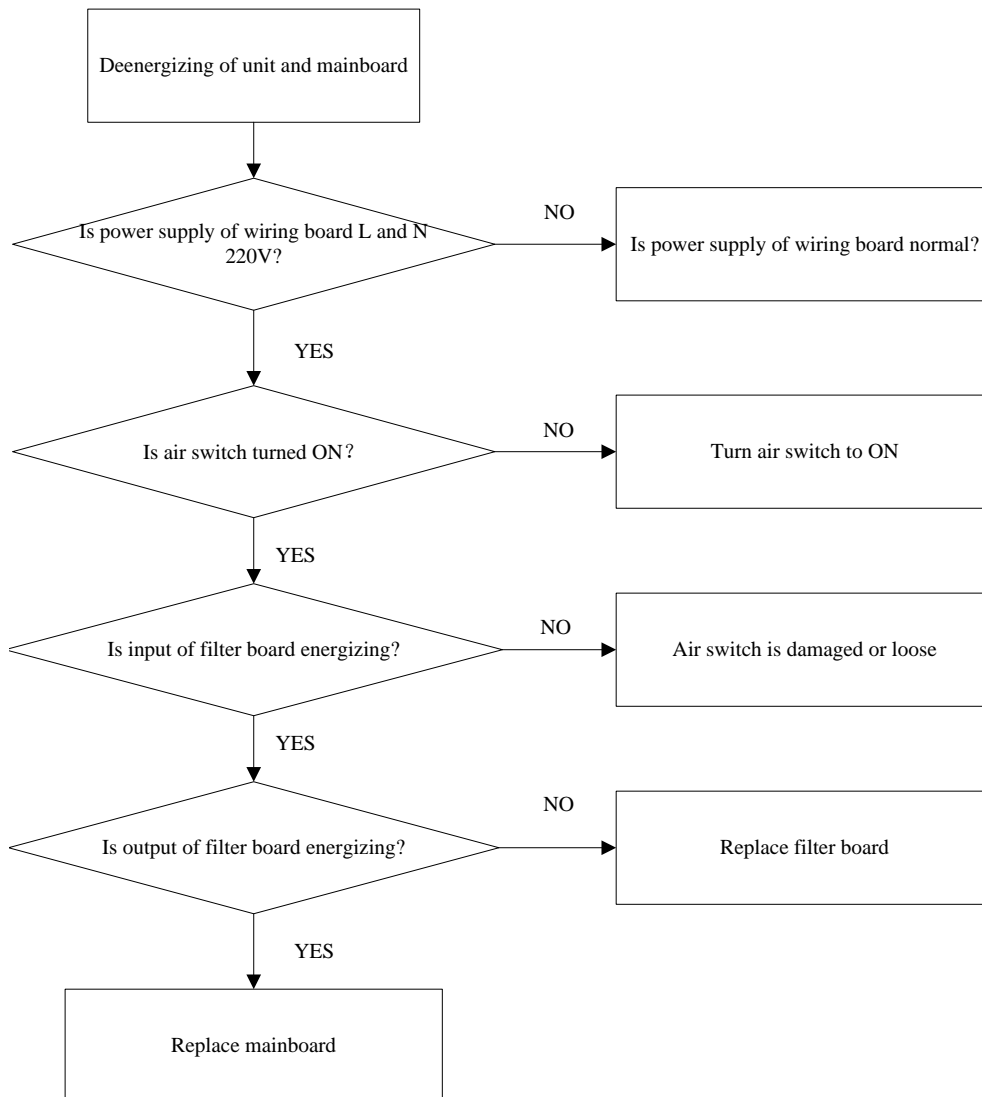

2.12 IPM High Temperature Protection

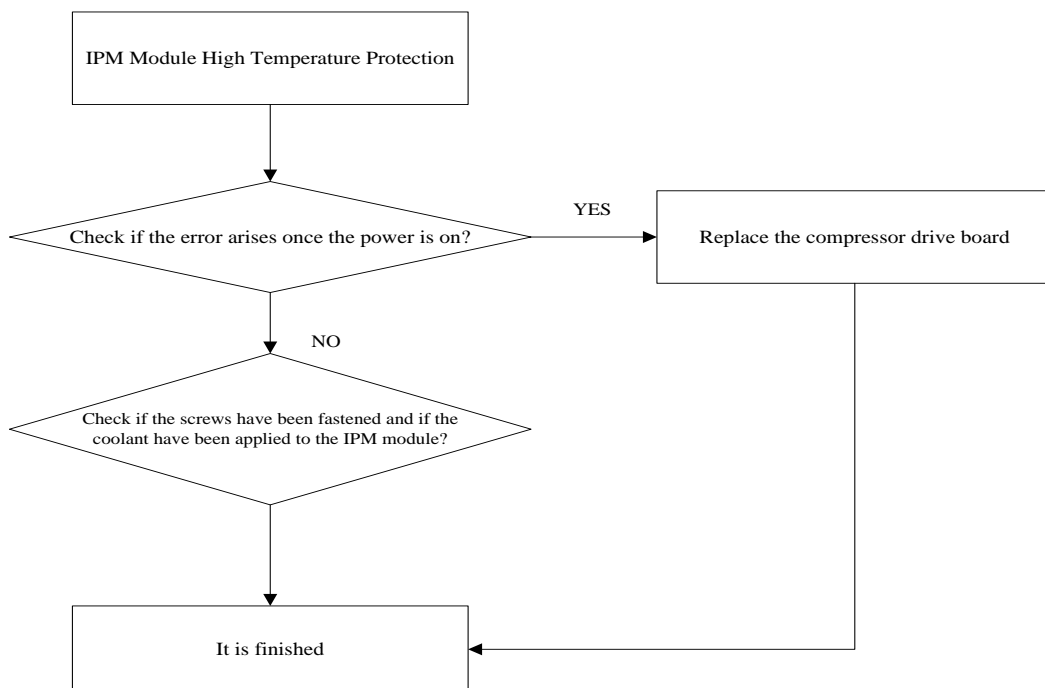

2.13 DC Bus High Voltage Protection

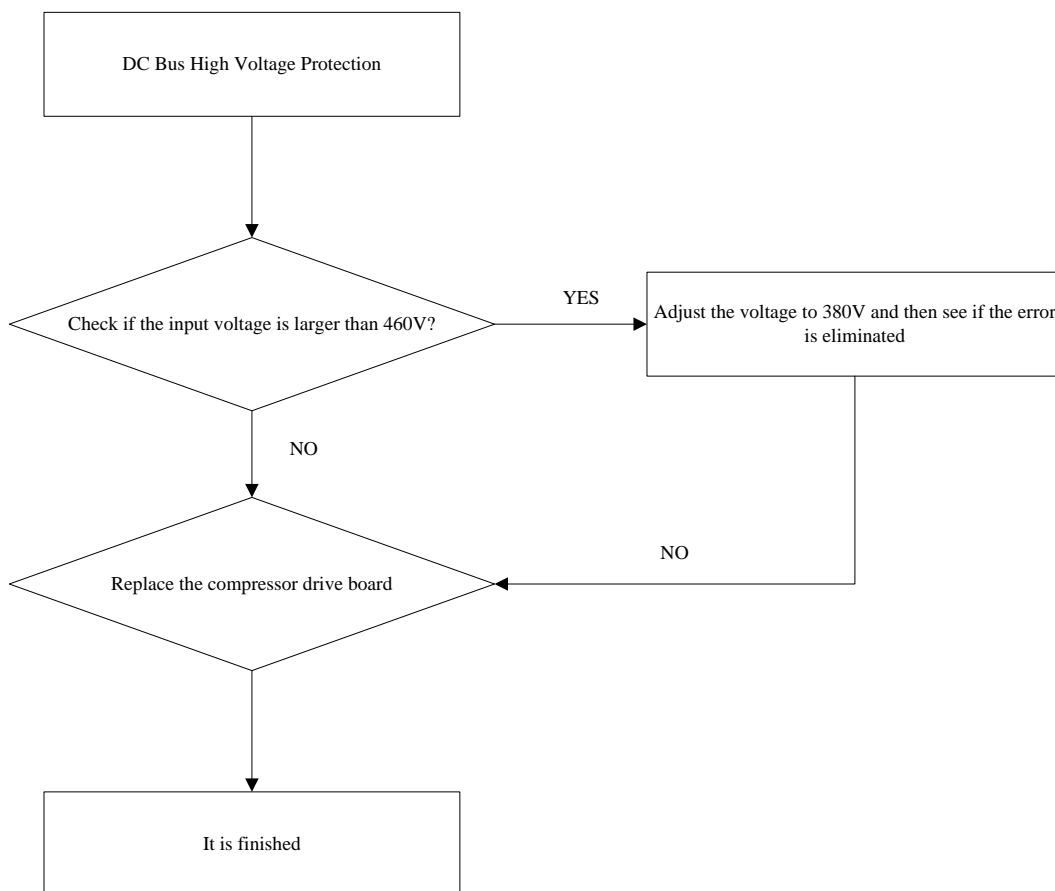



2.14 DC Bus Low Voltage Protection

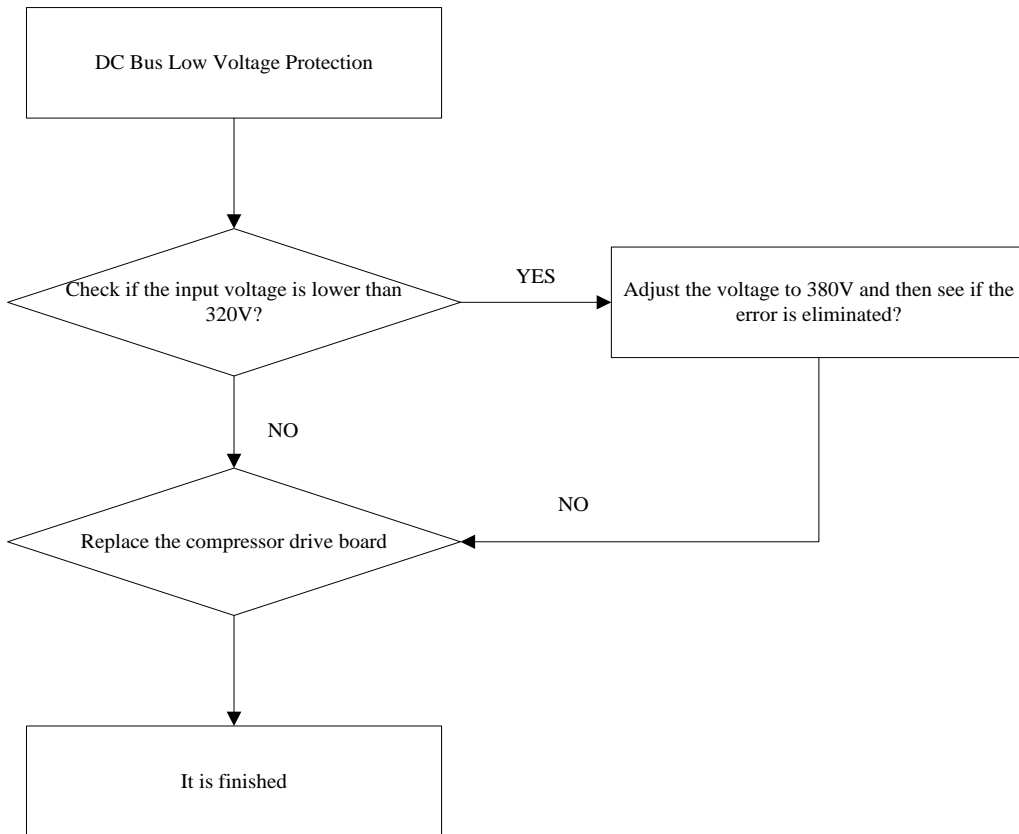

2.15 Open Phase Protection

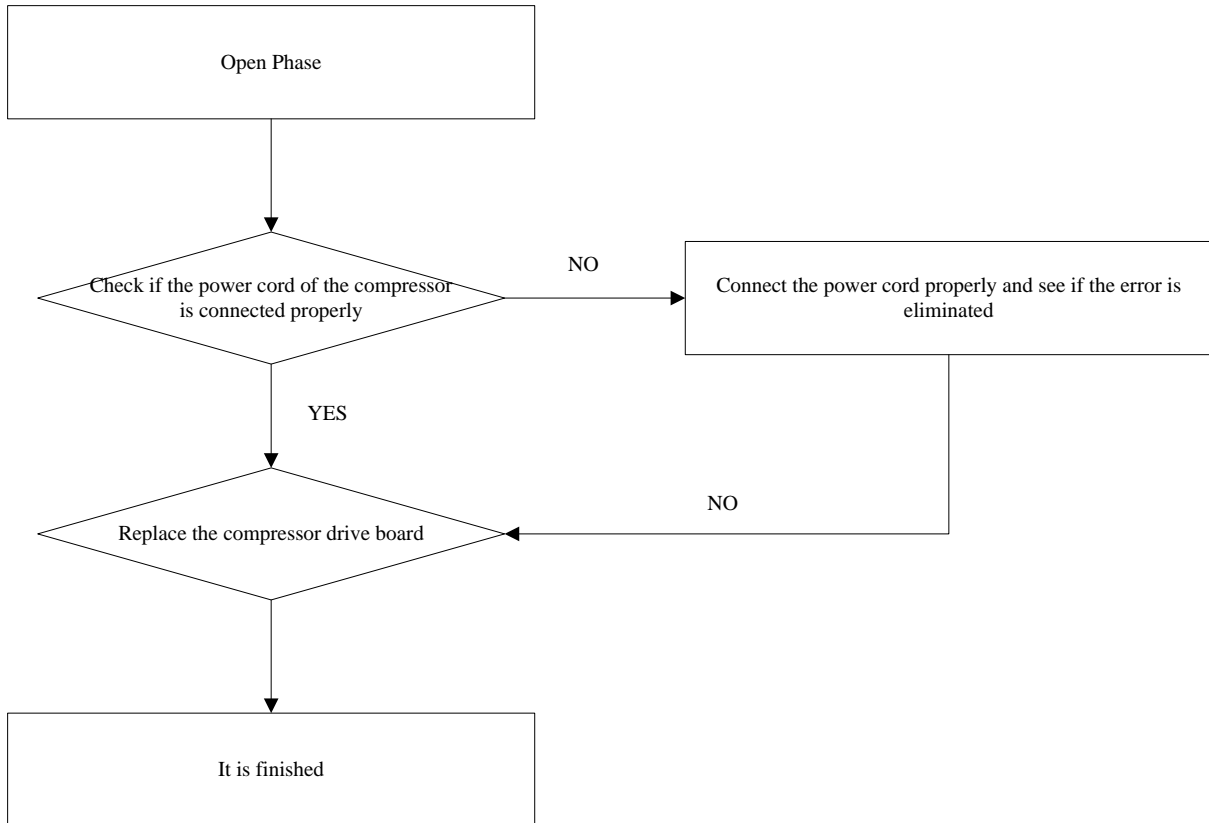

2.16 Phase-lacking protection of power

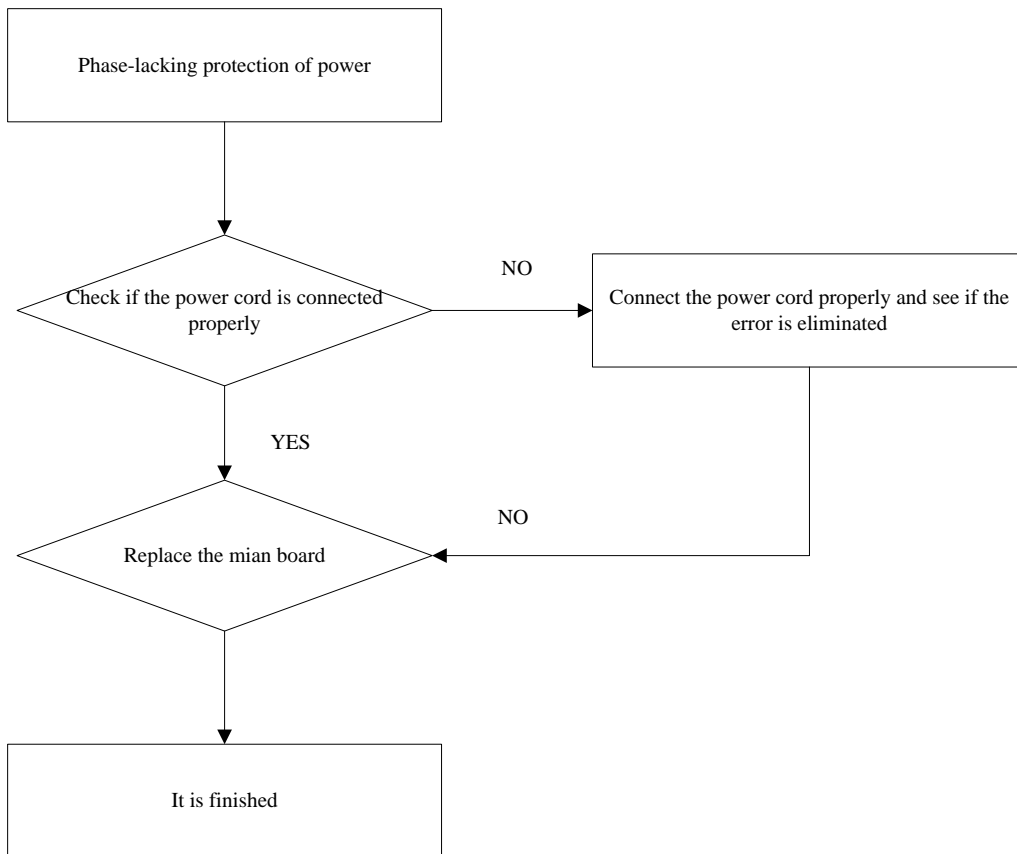

2.17 Desynchronizing protection of inverter compressor

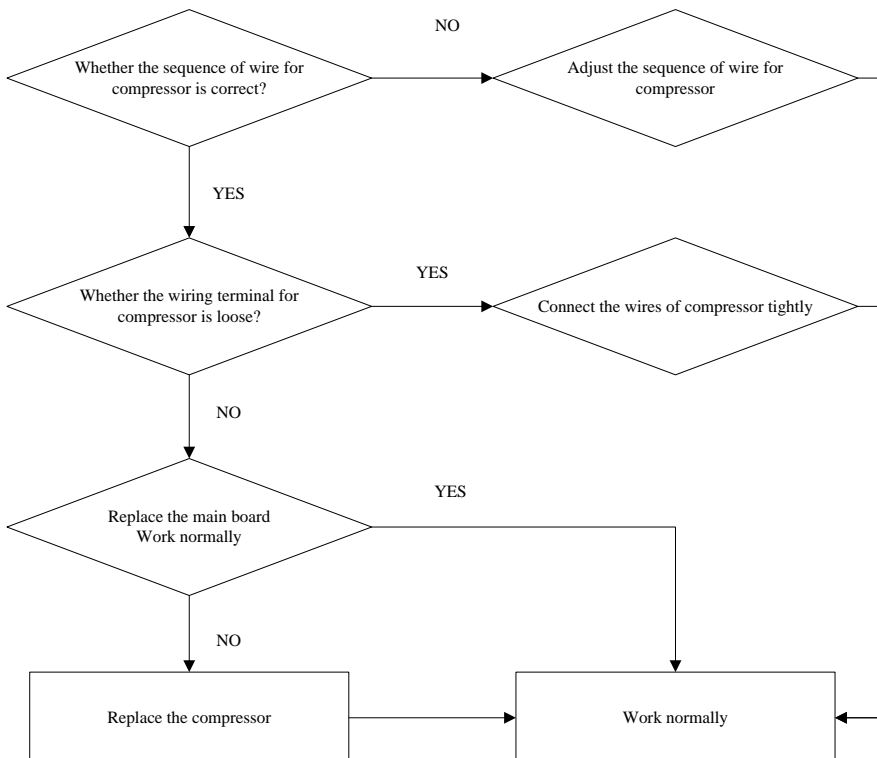

2.18 Malfunction of jumper

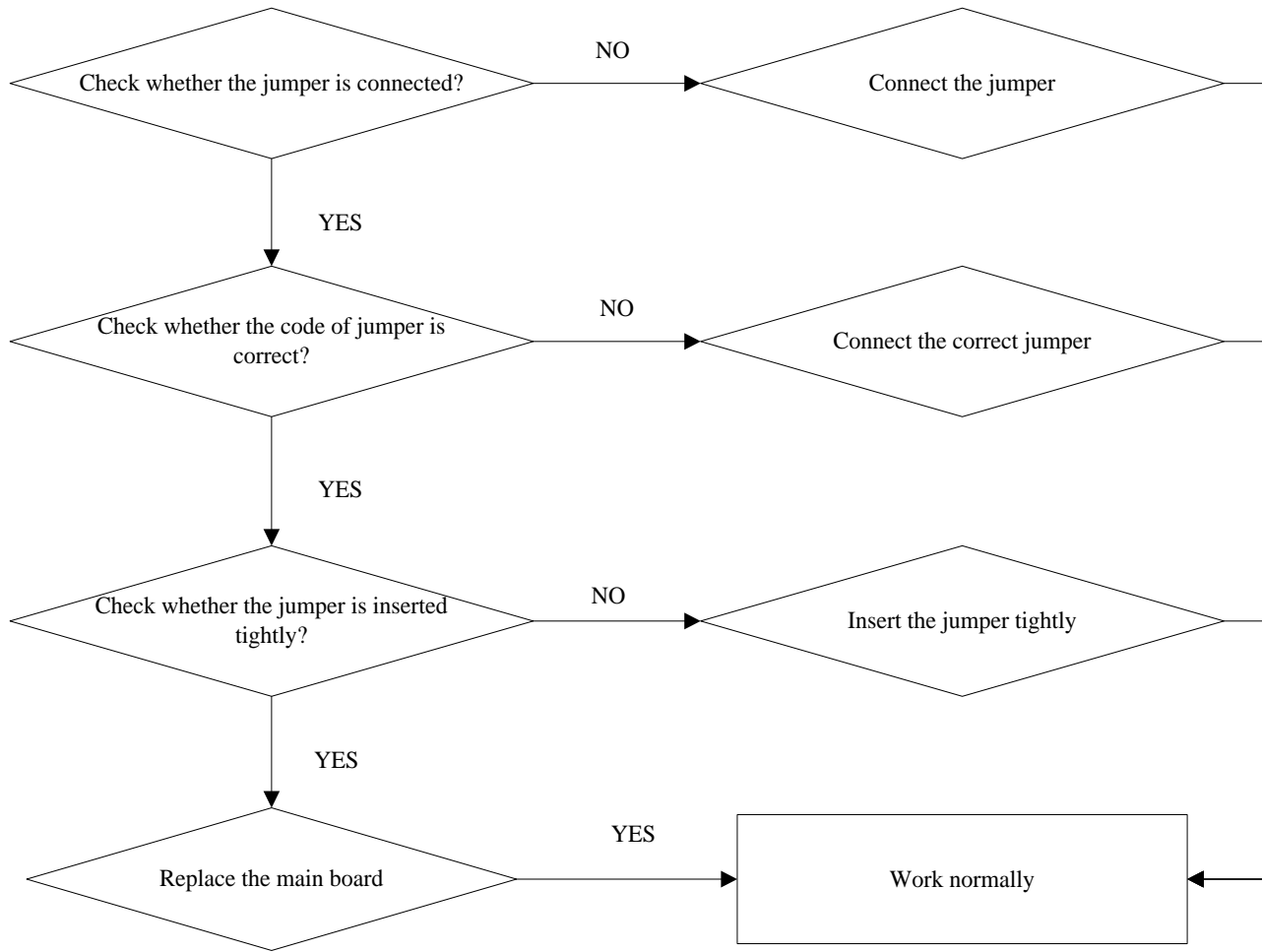

2.19 IPM Module Protection Error

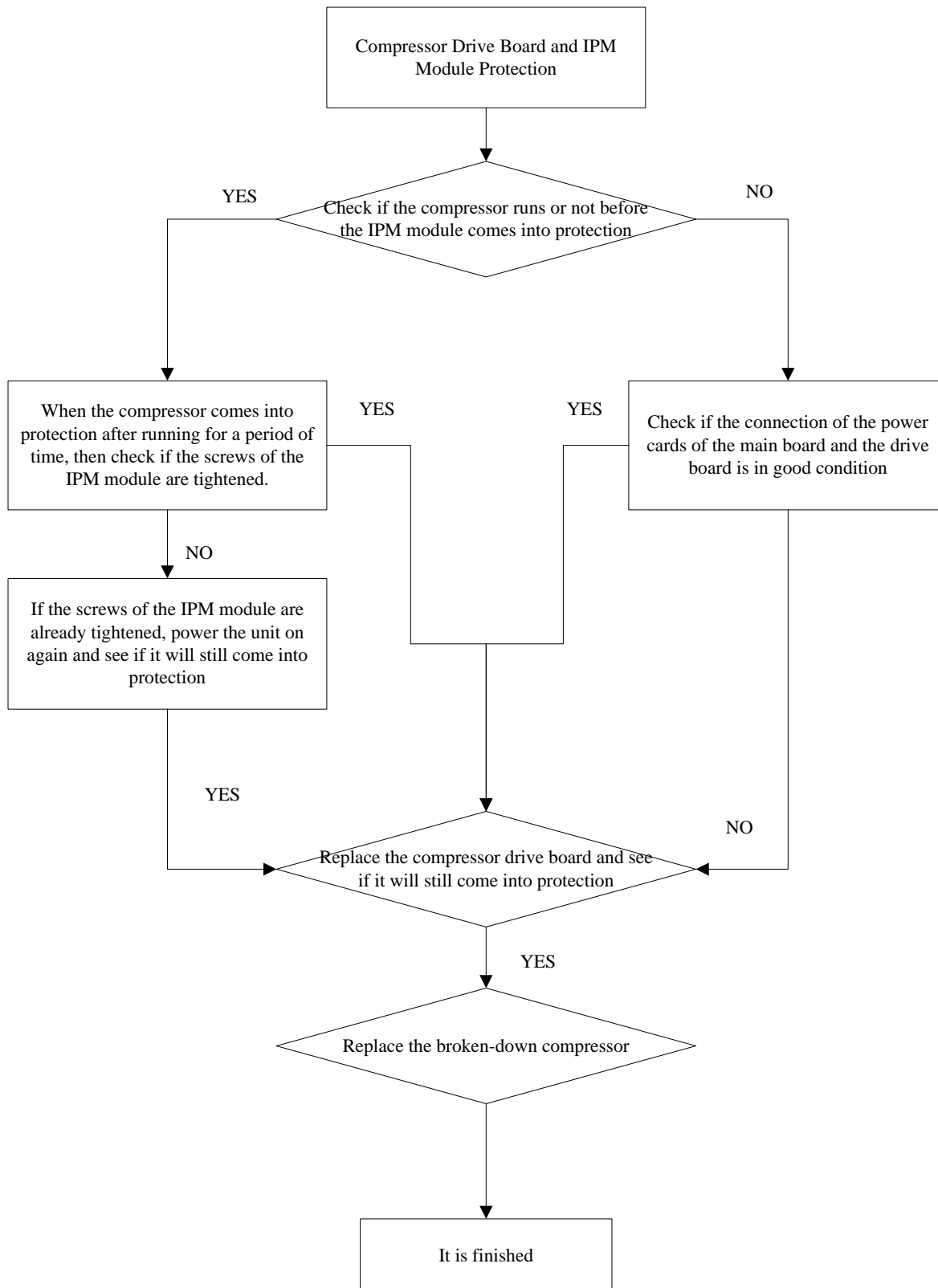



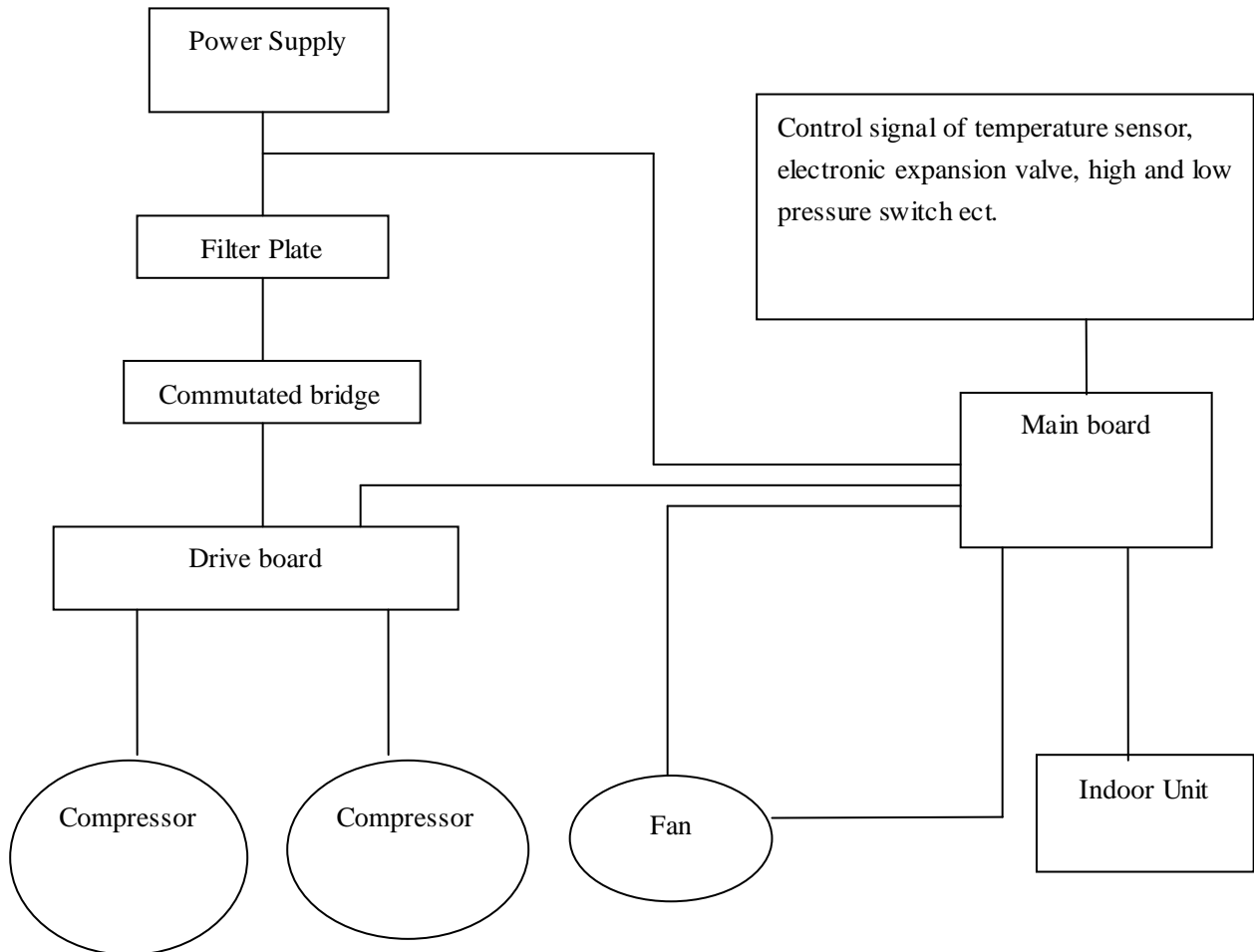

3 POWER DISTRIBUTION

3.1 Diagram of power distribution



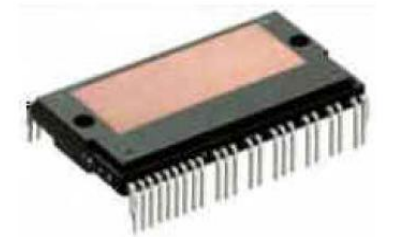

Note: The thick line represents power line while thin line represents the control line.)

3.2 Introduction of main electric parts of inverter system

Name	Photo	Introduction
Filter plate		<p>It is mainly used for filtering the interference of the power supply and prevent the unit from interfering the power supply so that the operation of the unit will not affect the other electric appliances such as TV.</p>
Drive Board		<p>Drive board is the control board of DC inverter compressor, which provides the control signal of changeable voltage, current, frequency for compressor.</p>
Main Board		<p>It is used to control the entire unit with the control logic.</p>
IPM Module		<p>IPM module is integrated with 3 pair complementary IGBT tube, whose connection and disconnection are controlled through PWM so that DC bus voltage is imposed to the winding of compressor. The magnetic field will enable the rotor to rotate for running of the compressor</p>

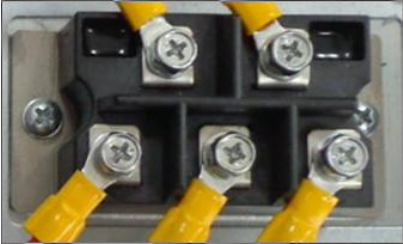

<p>Commutated bridge</p>		<p>It is used to transform the three-phase AC input power into DC power</p>
<p>Reactor</p>		<p>It is used to reduce the current harmonics and effectively restrain the interference on the network.</p>

3.3 Wiring diagram

Note: This drawing is just for reference; please always refer to the electric wiring stuck to the unit for actual wiring.

GMV-280WL/A-X, GMV-250WL/A-X, GMV-224WL/A-X

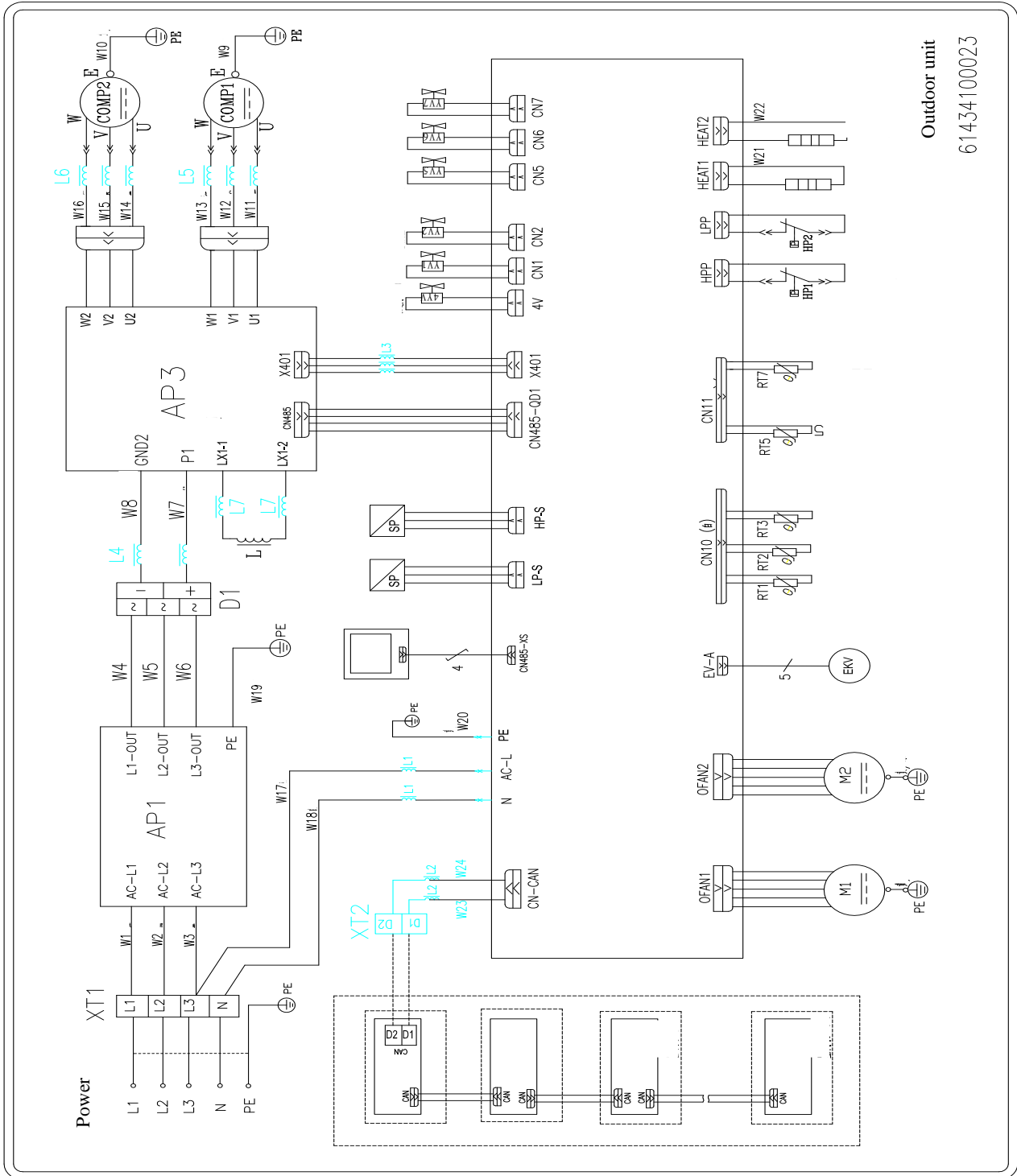



4 DISASSEMBLY AND ASSEMBLY PROCEDURE OF MAIN PARTS

4.1 Introduction of key parts

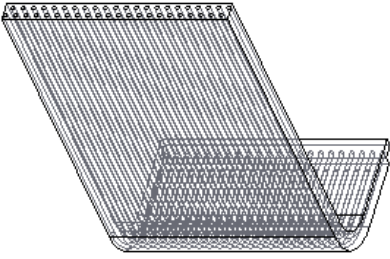
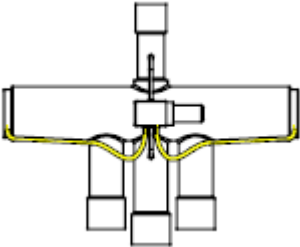
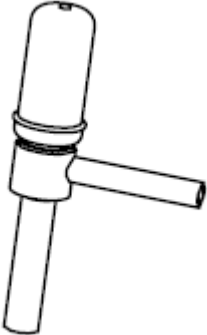
Photo	Name	Function
	Compressor	Core part of air conditioning system. It sucks low temperature and low pressure gas, compress it to high temperature and high pressure gas, and then discharge it.
	Heat Exchanger	Used for heat exchange between refrigerant and flow air
	4-way Valve	It changes the flow direction of refrigerant for switching between cooling and heating
	Electric Expansion Valve	Throttling device. It transforms high pressure refrigerant liquid into low pressure steam

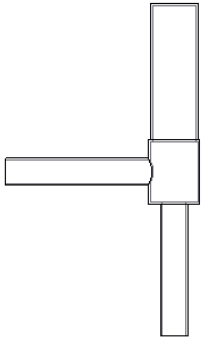
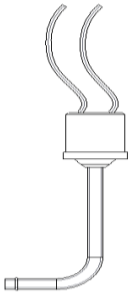
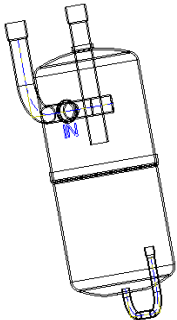
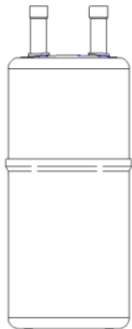
	<p>Solenoid valve</p>	<p>Control to the high-voltage current: open upon power on; close upon power off</p>
	<p>High-pressure Sensor</p>	<p>Detects the high pressure value in the system in real time mode for compressor protection and other control functions</p>
	<p>Oil Separator</p>	<p>It stays between discharge outlet of compressor and inlet of condenser. It used for separating the lubricant oil of compressor when the high temperature and high pressure refrigerant gas is discharged from the compressor</p>
	<p>Gas-liquid Separator</p>	<p>It stays between outlet of evaporator and suction outlet of compressor. It used for separating low temperature and low pressure refrigerant</p>

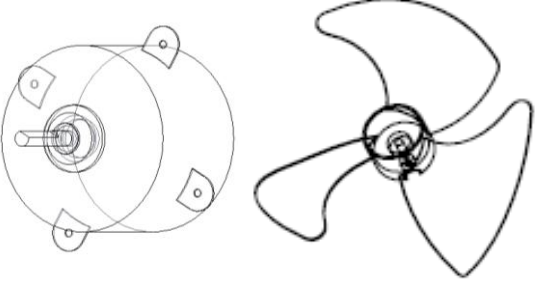
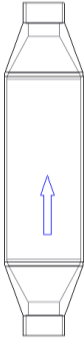
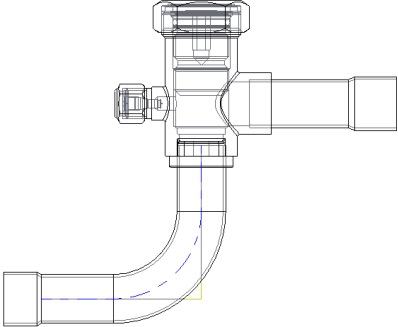

	<p>Fan Motor</p>	<p>Strengthens heat exchanging</p>
	<p>One-way valve</p>	<p>Controls refrigerant flow direction</p>
	<p>Cut-off Valve</p>	<p>It used for connecting indoor unit and outdoor unit, and used for maintenance and installation</p>

4.2 Removal of key parts

Removal operation for panel

Remark: Before removing the panel, please make sure that the unit is disconnected with the power

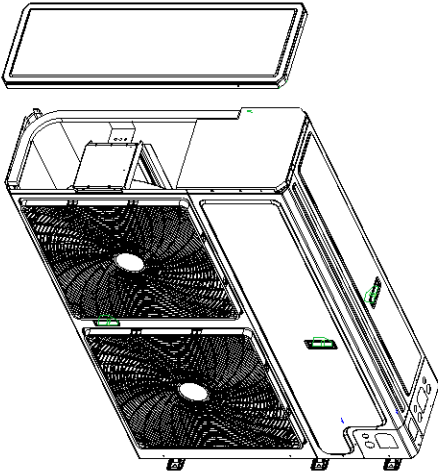
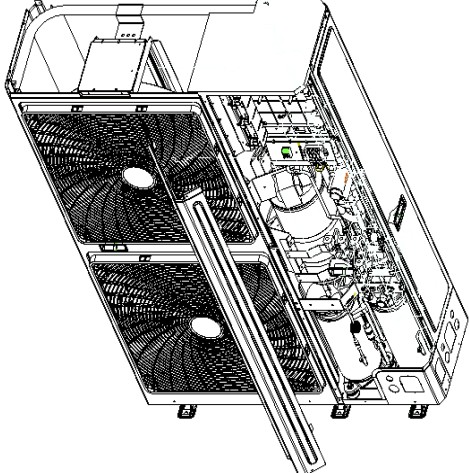
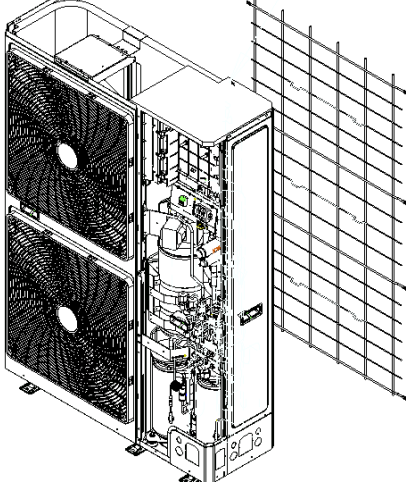
Process	Photo	Operation Instruction
<p>1、 Remove top cover</p>		<ul style="list-style-type: none"> ● Loose the screws fixing the top cover with screw driver ● Hold the top cover upwards and then put it on the floor flatly
<p>2、 Remove front side plate sub-assy</p>		<ul style="list-style-type: none"> ● Loose the screw fixing the front side plate with screwdriver ● Hold the front side plate upwards and then put it on the floor flatly
<p>3、 Remove front panel and grille</p>		<ul style="list-style-type: none"> ● Loose the screws fixing the front panel and grille with screwdriver ● Put the front panel and grille on the floor flatly

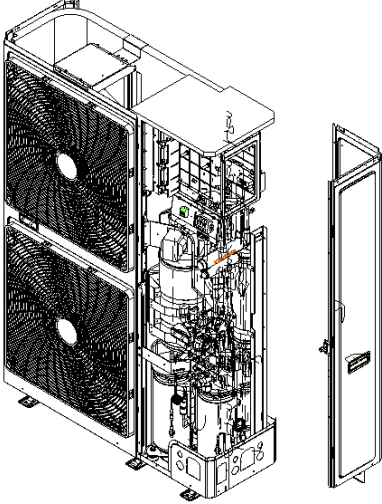
<p>4、 Remove left side plate and rear side plate</p>		<ul style="list-style-type: none"> ● Loose screws fixing left side plate and rear side plate with screwdriver ● Remove the rear side plate
--	---	--

Removal operation for blade

Remark: Before removing the motor, please make sure that the unit is disconnected with the power.

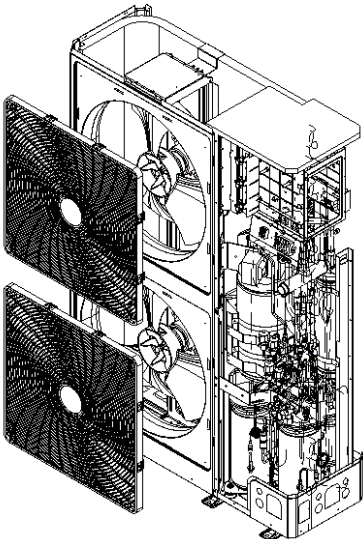
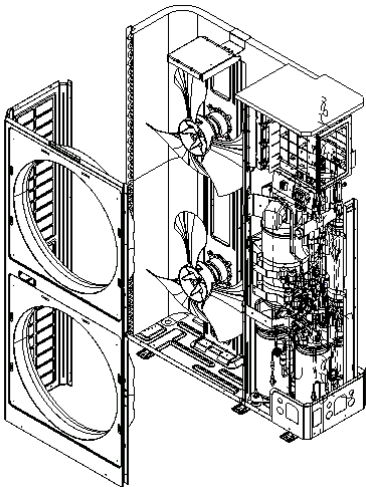
Process	Photo	Operation Instruction
<p>1、 Remove grille</p>		<ul style="list-style-type: none"> ● Loose screws fixing the panel with screwdriver ● Then remove the grille
<p>2、 Remove front side plate sub-assy</p>		<ul style="list-style-type: none"> ● Loose the screw fixing the front side plate with screwdriver ● Hold the front side plate upwards and then put it on the floor flatly

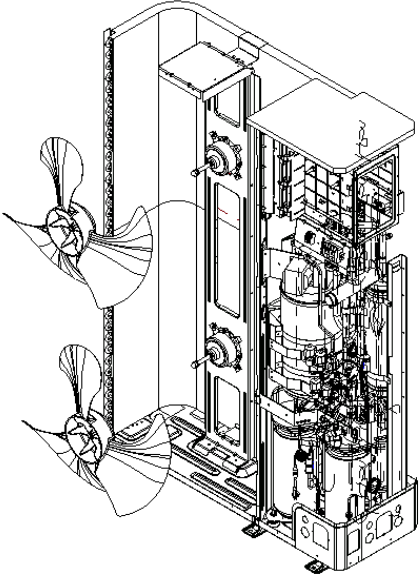
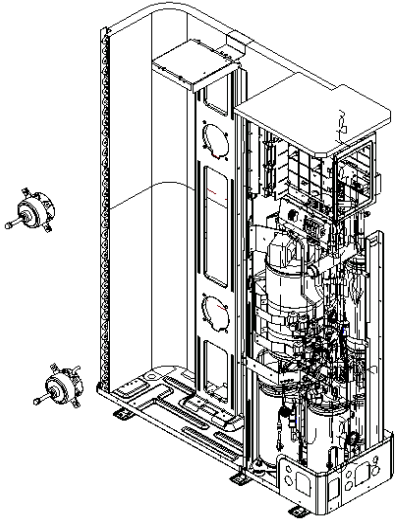
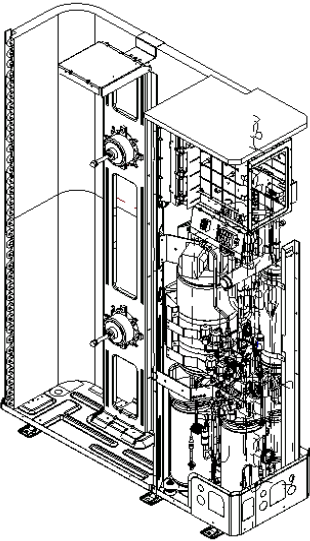
<p>3、 Remove blade</p>		<ul style="list-style-type: none"> ● Loosen nuts fixing the blade with wrench ● Then remove the blade and put it on the floor flatly
<p>4、 Remove motor</p>		<ul style="list-style-type: none"> ● Loose screws fixing the motor with screwdriver ● Then remove the power cord of motor ● Take out the damaged motor
<p>5、 Install motor</p>		<ul style="list-style-type: none"> ● Replace the motor, tighten screws with screwdriver and then connect the power cord of motor

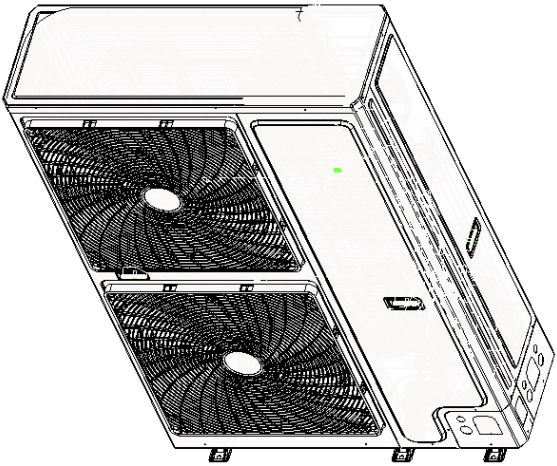
<p>6、Assemble unit</p>		<ul style="list-style-type: none"> ● Assemble the unit in the the converse sequence
------------------------	---	--

Removal operation of compressor

Remark: Before removing the compressor,make sure that there is no refrigerant inside the pipe system and that the power has been cut off.

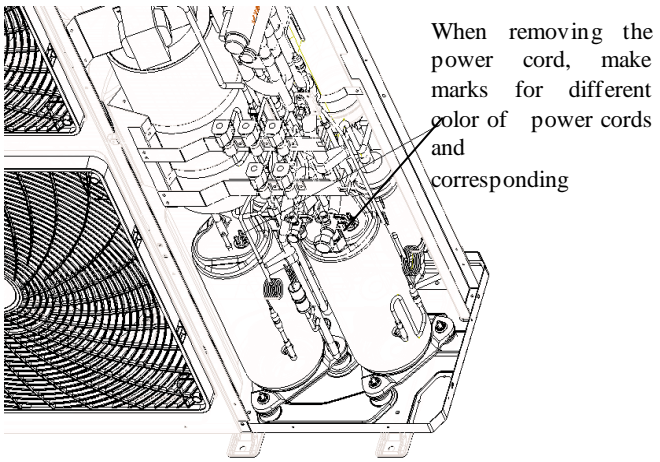
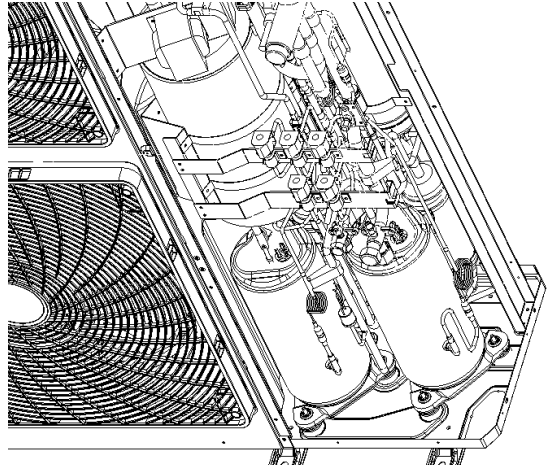
Process	Photo	Operation Instruction
<p>1、Remove wiring cover of compressor</p>		<ul style="list-style-type: none"> ● Loose screws fiixng the compressor with screw-driver ● Then pull out the power cord ● Note:When removing the power cord, make marks for different color power cords and corresponding wiring terminals for wrong terminal
<p>2、Disconnet the compressor and the conneting pipe</p>		<ul style="list-style-type: none"> ● Weld suction pipe and discharge pipe of compressor ● Then pull out the connection pipe from the compressor ● Note: During welding process, do not let the flame burn out other parts

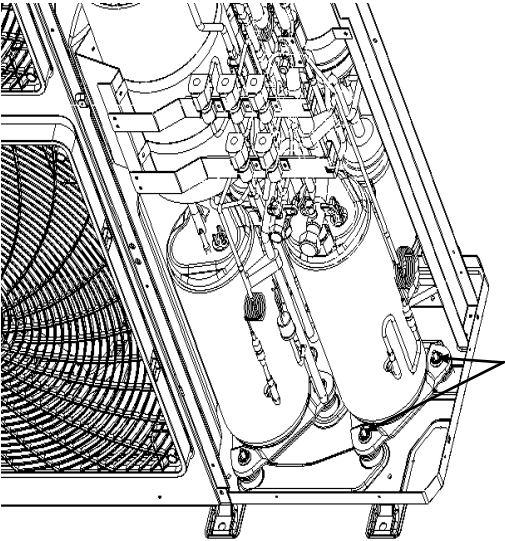
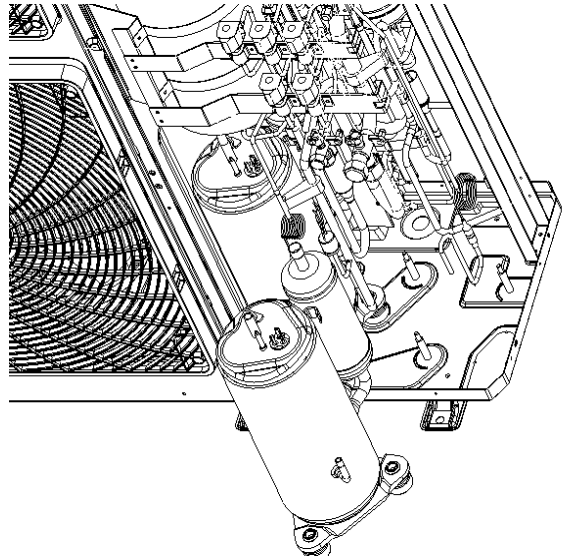
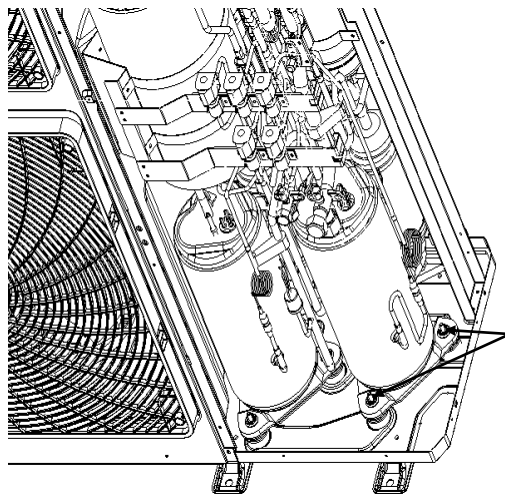
<p>3、Loose nuts fixing the foot of compressor</p>	 <p>Twist off the nuts for compressor with wrench</p>	<ul style="list-style-type: none"> ● Twist off the nuts for compressor with wrench
<p>4、Remove the chassis from compressor</p>		<ul style="list-style-type: none"> ● Take out the compressor and replace it ● Note: When replacing the compressor, do not damage nearby pipelines and other parts
<p>5、Fix the new compressor on the base</p>	 <p>Tighten the nuts for compressor with wrench</p>	<ul style="list-style-type: none"> ● After replacing the compressor, fix the nuts at the bottom of compressor

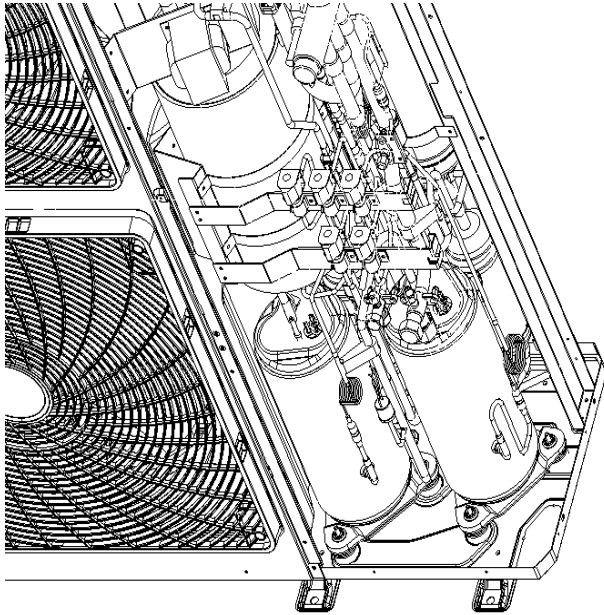
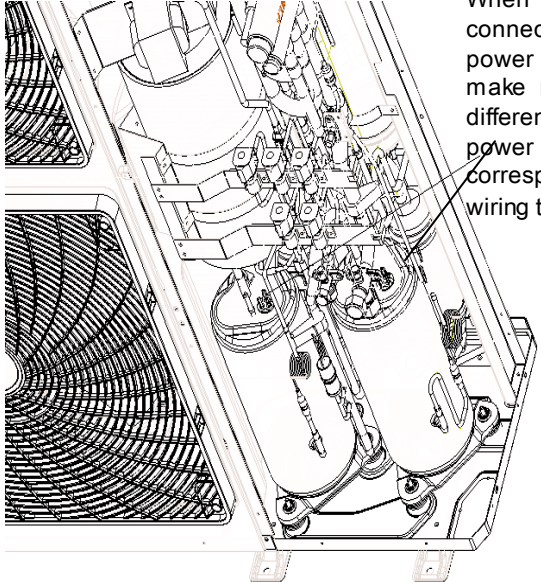
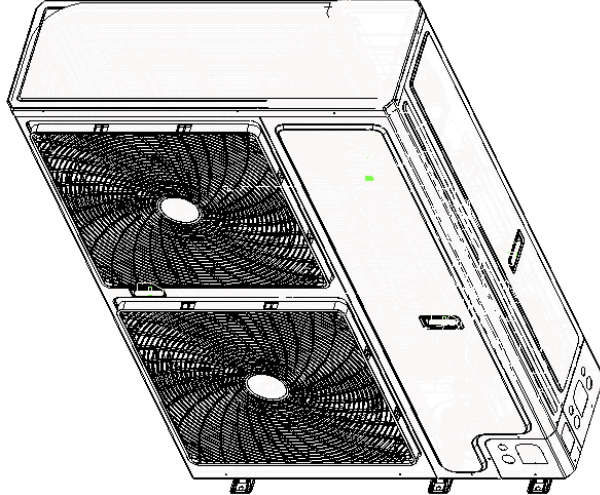
<p>6. Connect suction pipe and discharge pipe of compressor and pipeline of system again</p>		<ul style="list-style-type: none"> ● Weld the connection pipe of compressor, connect the pipeline and compressor ● Note: During welding process, do not let flame burn out other parts
<p>7. Connect the power cord of compressor well</p>	 <p>When connecting the power cord, make marks for different color power cords and corresponding wiring terminals</p>	<ul style="list-style-type: none"> ● Loose screws fixing the power cord with screw-driver ● connect the power cord well again ● Note: When connecting the power cord, make marks for different color power cords and corresponding wiring terminals
<p>8. Check and open the upper cover plate</p>		<ul style="list-style-type: none"> ● Check whether the pipeline is connected well ● Check whether all parts and connection wires are connected well ● If there's no problem after checking, install front and rear cover plates.

Removal operation for 4-way valve

Remark: Before removing the 4-way valve, make sure that there is no refrigerant inside the pipe system and that the power has been cut off.

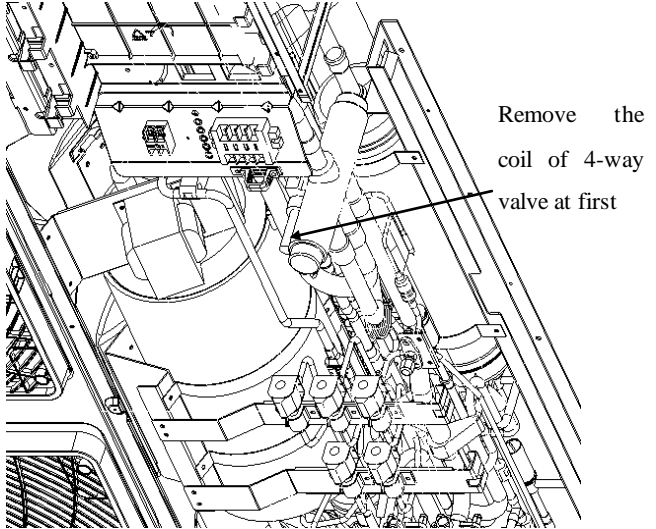
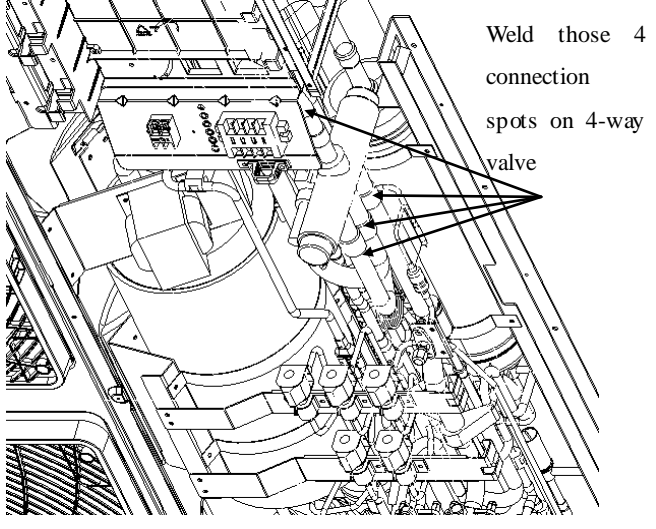
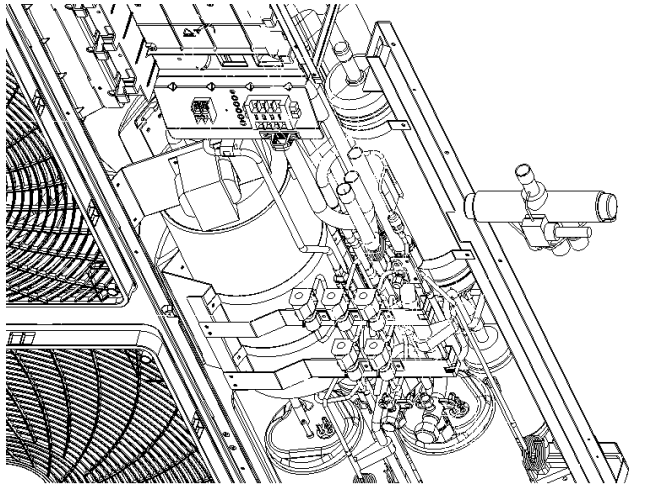
Process	Photo	Operation Instruction
<p>1、 Disconnect the coil of 4-way valve from the 4-way valve</p>		<ul style="list-style-type: none"> ● Remove the coil of 4-way valve at first
<p>2、 Disconnect the 4-way valve and connection pipeline</p>		<ul style="list-style-type: none"> ● Weld those 4 connection spots on 4-way valve, and then pull out the connection pipe ● Note: During welding process, do not let the flae burn out other parts
<p>3、 Replace 4-way valve</p>		<ul style="list-style-type: none"> ● Replace 4-way valve ● Note: During welding process, do not let the flame burn out other parts

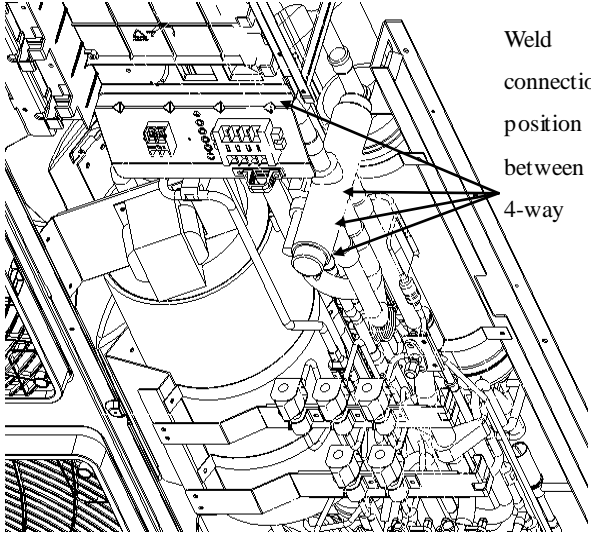
<p>4、Replace 4-way valve</p>	 <p>Weld the connection position between 4-way valve</p>	<ul style="list-style-type: none"> ● Weld the connection position between 4-way valve and pipeline ● Note: During welding process, do not let flame burn out other parts
------------------------------	---	--

Removal operation for electronic expansion valve

Remark: Before removing the electronic expansion valve, make sure that there is no refrigerant inside the pipe system and that the power has been cut off.

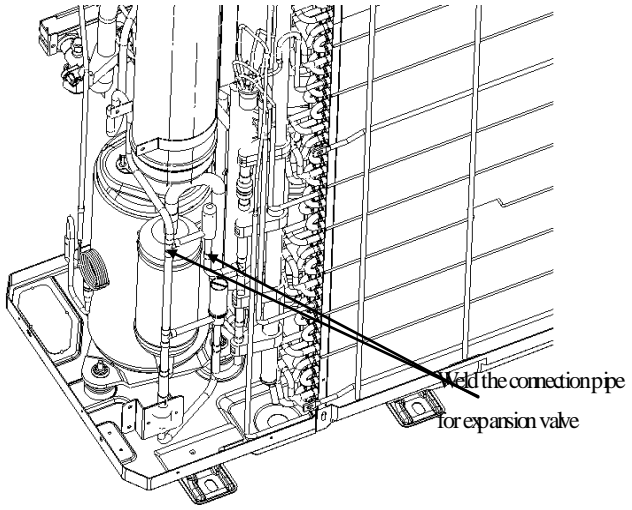
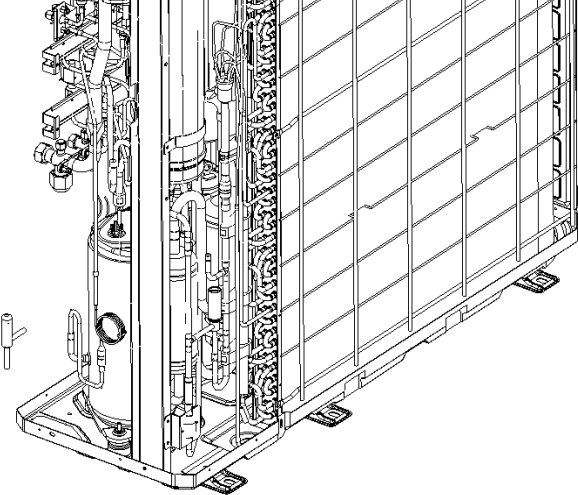
Process	Photo	Operation Instruction
<p>1、Disconnet the electronic expansion valve and the conneting pipe</p>	 <p>Weld the conection pipe for expansion valve</p>	<ul style="list-style-type: none"> ● Remove the coil of electroc expansion valve at first ● Weld the connection pipe for expansion valve, and then pull out the connection pipe ● Note : During welding process, do not let flame burn out other parts
<p>2. Take out the electronic expansion valve and replace it</p>		<ul style="list-style-type: none"> ● Take out the electronic expansion valve and replace it

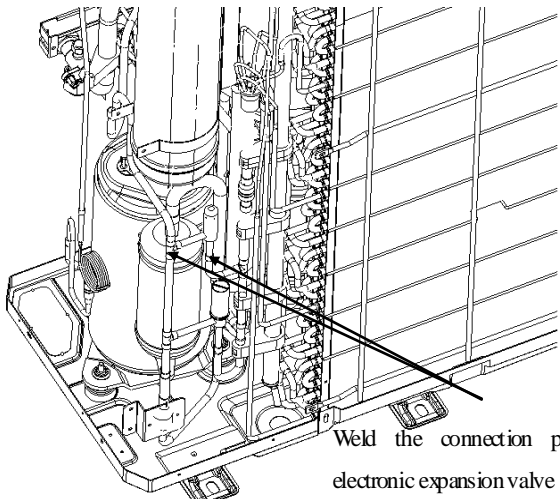
<p>3、 Replace the electronic expansion valve</p>	 <p>Weld the connection pipe of electronic expansion valve</p>	<ul style="list-style-type: none"> ● Weld the connection pipe of electronic expansion valve ● Install the coil of electronic expansion valve ● Note : During welding process, do not let the flame burn out other parts
--	---	--

Removal operation Oil Separator

Remark: Before removing the oil separator, make sure that there is no refrigerant inside the pipe system and that the power has been cut off.

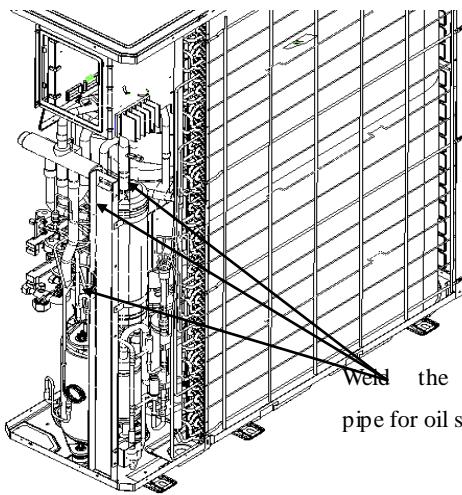
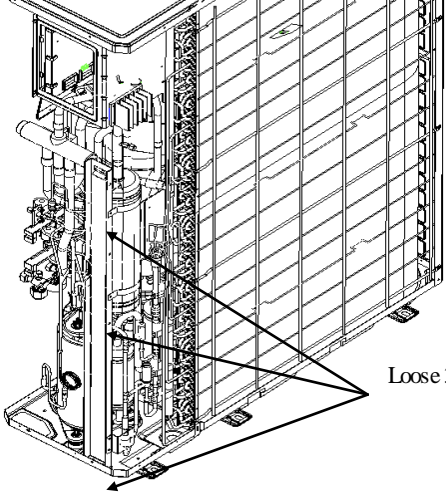
Process	Photo	Operation Instruction
<p>1、 Disconnet the oil separator and the conneting pipe</p>	 <p>Weld the connection pipe for oil separator</p>	<ul style="list-style-type: none"> ● Remove the oil separator at first ● Weld the connection pipe for oil separator, and then pull out the connection pipe ● Note : During welding process, do not let flame burn out other parts
<p>2、 Remove the oil separator</p>	 <p>Loose 3 screws</p>	<ul style="list-style-type: none"> ● Loose the screws fixing the oil separator with screwdriver

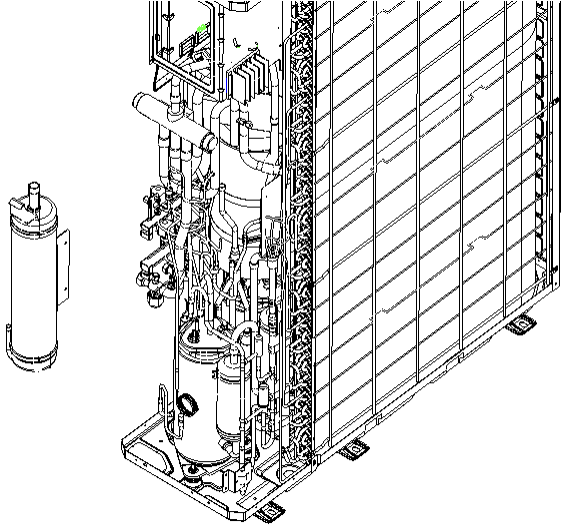
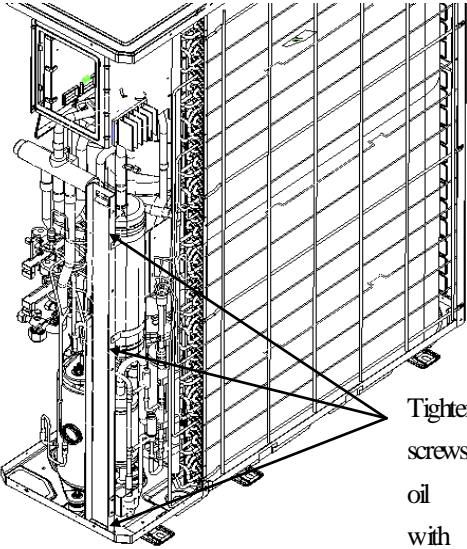
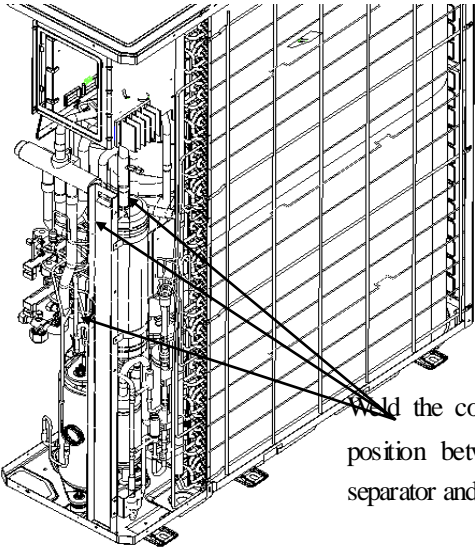
<p>3、 Replace the oil separator</p>		<ul style="list-style-type: none">● Replace the oil separator
<p>4、 Mount the new oil separator</p>	 <p>Tighten the screws fixing the oil separator with</p>	<ul style="list-style-type: none">● Tighten the screws fixing the oil separator with screwdriver
<p>5、 Replace oil separator</p>	 <p>Weld the connection position between oil separator and pipeline</p>	<ul style="list-style-type: none">● Weld the connection position between oil separator and pipeline● Note: During welding process, do not let flame burn out other parts

Removal operation of gas liquid separator

Remark: Before removing the Gas-liquid Separator, make sure that there is no refrigerant inside the pipe system and that the power has been cut off.

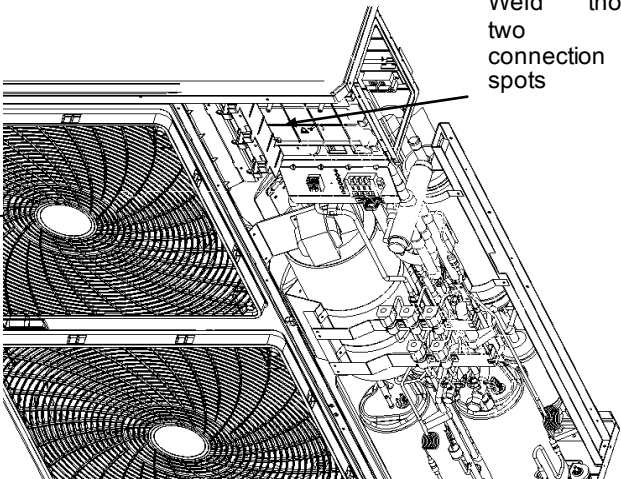
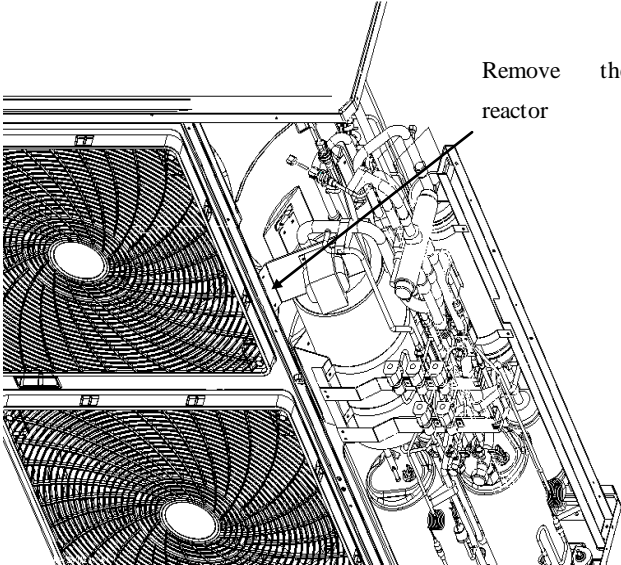
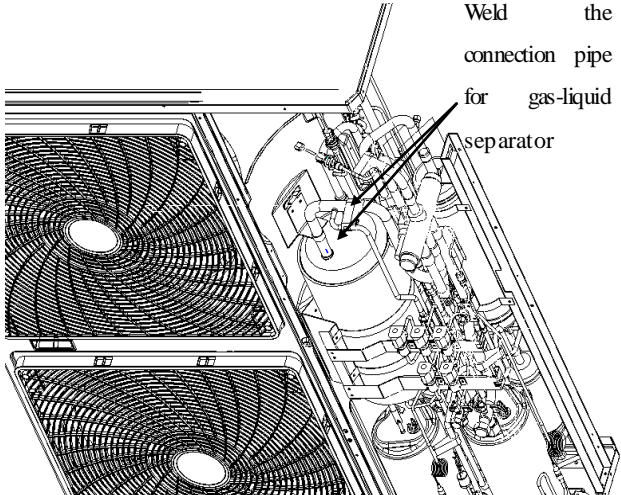
Process	Photo	Operation Instruction
1、 Remove the electric box assy	 <p>Weld those two connection spots</p>	<ul style="list-style-type: none"> ● Remove the electric box assy
2、 Remove the reactor	 <p>Remove the reactor</p>	<ul style="list-style-type: none"> ● Remove the reactor ● Dismantle the installation supporting frame
3、 Disconnet the gas-liquid separator and the conneting pipe	 <p>Weld the connection pipe for gas-liquid separator</p>	<ul style="list-style-type: none"> ● Remove the gas-liquid separator at first ● Weld the connection pipe for gas-liquid separator, and then pull out the connection pipe ● Note : During welding process,do not let flame burn out other parts

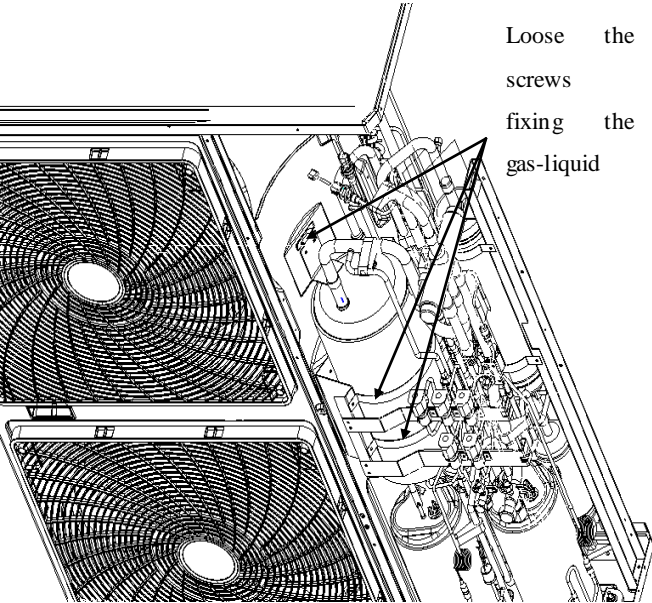
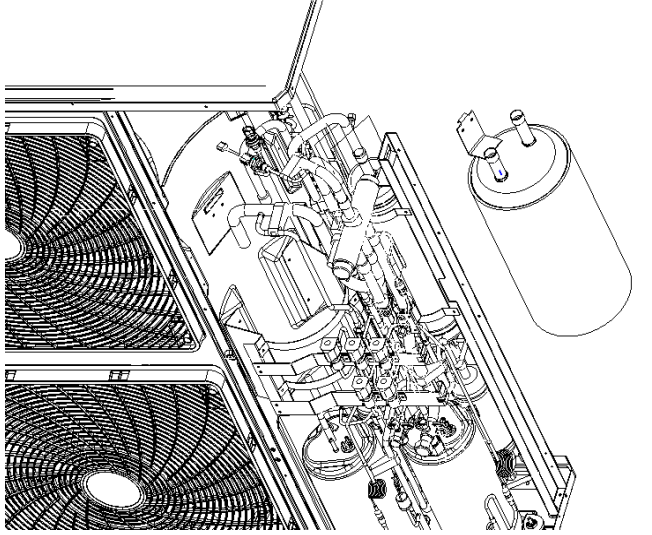
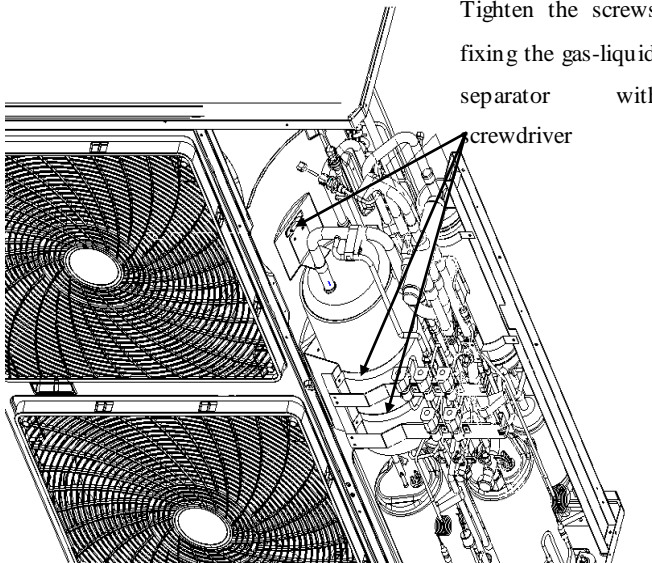

<p>4、 Remove the gas-liquid separator</p>	 <p>Loose the screws fixing the gas-liquid</p>	<ul style="list-style-type: none">● Loose the screws fixing the gas-liquid separator with screw driver
<p>5、 Replace the gas-liquid separator</p>		<ul style="list-style-type: none">● Replace the gas-liquid separator
<p>6、 Mount the gas-liquid separator</p>	 <p>Tighten the screws fixing the gas-liquid separator with screwdriver</p>	<ul style="list-style-type: none">● Tighten the screws fixing the gas-liquid separator with screw driver

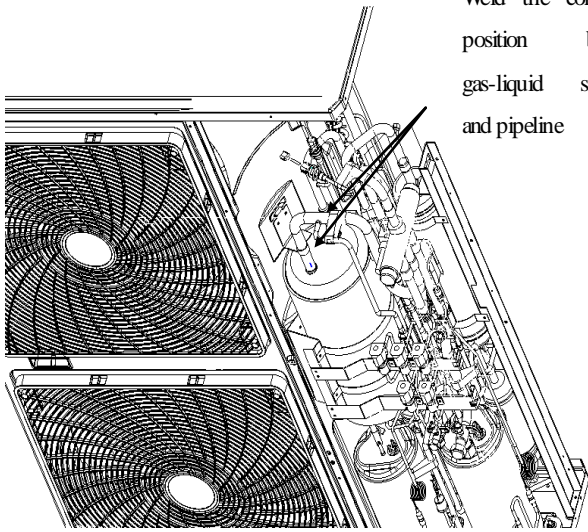
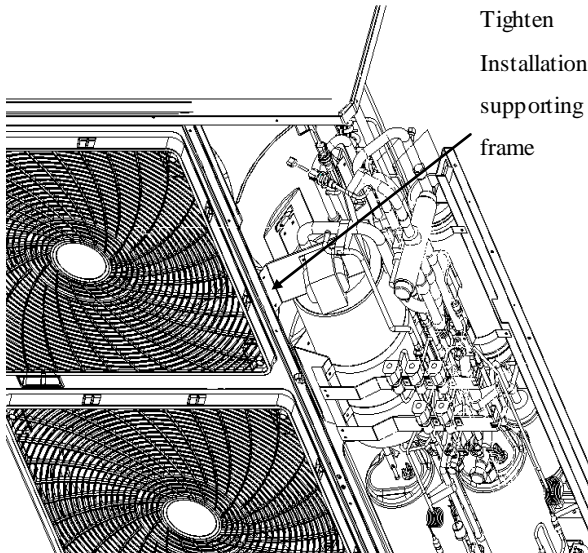
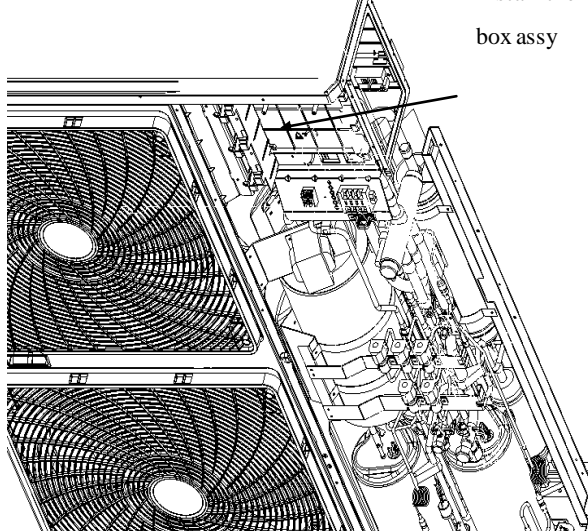
<p>7、Weld the connection pipe for gas-liquid separator</p>	 <p>Weld the connection position between gas-liquid separator and pipeline</p>	<ul style="list-style-type: none"> ● Weld the connection position between gas liquid separator and pipeline ● Note: During welding process, do not let flame burn out other parts
<p>8、Install the reactor</p>	 <p>Tighten the Installation supporting frame</p>	<ul style="list-style-type: none"> ● Tighten the Installation supporting frame ● Install the reactor
<p>9、Install the electric box assy</p>	 <p>Install the electric box assy</p>	<ul style="list-style-type: none"> ● Install the electric box assy



5 COMMON MAINTENANCE

5.1 System leak hunting

When refrigerant piping is to be installed, pressure maintaining and leak hunting is required for the piping. After refrigerant piping is in connection with indoor unit and outdoor unit, pressure maintaining and leak hunting is also required. The purpose of the test is to check whether any leak is existent at threaded connection of indoor unit and outdoor unit and at new welded points.

Steps:

- A. Fill the system pipeline with 20.0kgf/cm² Nitrogen
- B. Check the main connections with soapy water, and mark it immediately if any leak.
- C. After the detection is completed, fill the pipeline with 0.5±0.1kgf/cm² (relative pressure) Nitrogen. Repair welding shall be performed immediately
- D. After repair welding, Nitrogen is charged to reach 25.0kgf/cm² and remains at the pressure for 48h. After that, check the reading of pressure gauge and the pressure drop calculated according to the following formula should not be more than 1% of the test pressure. Otherwise, find out the reason and clear the leakage until eligibility is reached.

$$\Delta P = P1 - P2 \cdot (273 + T1) / (273 + T2)$$

The formula: ΔP —Pressure drop (MPa) ;

P1, P2—Pressure of nitrogen at the beginning and the end of experiment (MPa) ;

T1, T2—Temperature of nitrogen at the beginning and the end of experiment (°C) .

5.2 Vacuum drying for the system

5.2 Vacuum drying for the system

5.2.1 Selection requirement for the vacuum pump

Do not use different vacuum pump for vacuum-pumping for different refrigerant system;

The final vacuum for the vacuum pump should reach -0.1Mpa;

The air discharge volume for the vacuum pump should reach 4L/S above;

The precision of vacuum pump should reach 0.02mmHg above;

The system vacuum pump for R410A must be with check valve

5.2.2 Operation procedure and notices for Vacuum drying

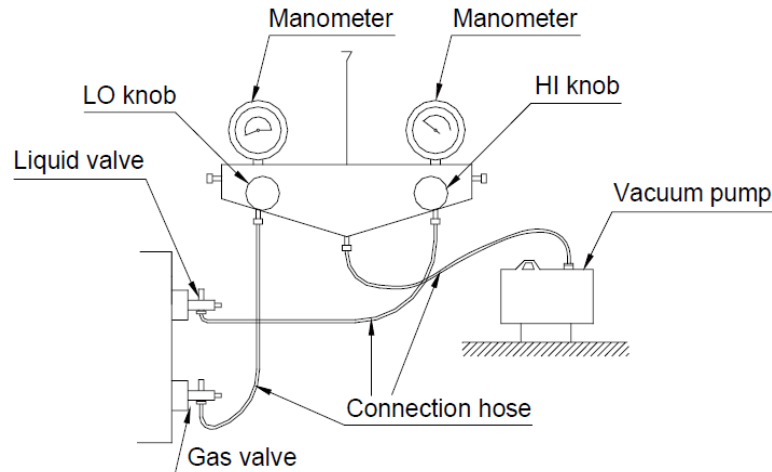

1) Operation procedure

- a. Before vacuum-pumping, please confirm that the cut-off valve for gas pipe and liquid pipe is at off status;
- b. Use charging conduct pipe to connect the governing valve and vacuum heat pump to the detection joint of gas valve and liquid valve;
- c. After vacuum-pumping for 4h, check whether the vacuum degree is reached to -0.1MPa or above; If not, there may be gas leakage. Please perform the leakage inspection again. If there's no gas leakage, please vacuum pump for another 2h.
- d. If the required vacuum degree can't be satisfied after vacuum-pumping for two times, there are water inside the pipeline. Please drain out the water by the method of vacuum damage. The detailed method: charge 0.05MPa nitrogen into the pipeline, vacuum pump for 2h and then keep the vacuum for 1h. If -0.1MPa vacuum degree still can't be reached, repeat this operation until the water is drained out completely.
- e. After evacuation, close the regulating valve, and 1 hour later check if its pressure goes up or not.

2) Notices:

- a. Vacuum pump for the gas pipe and liquid valve at the same time
- b. When turn off the vacuum pump to stop vacuum-pumping, please turn off the valve at first and then de-energize the vacuum pump
- c. Keep the vacuum pumping for 2h and confirm that the pressure of vacuum meter hasn't been increased.

5.3 Airtightness test

5.3.1 Importance of airtightness test

The airtightness of VRF system is the leak tightness of the pipeline for refrigerant, which the guarantee for safe and reliable operation. The leakage of refrigerant may affect the operation of air conditioner seriously, or even damage compressor and then lead to breakdown of system. Therefore, it needs to perform the airtightness test. If there's gas leakage after the system is installed completely, because the indoor ceiling decoration are all finished, it's will be very difficult to find out the leakage point. Thus, the airtightness test of the system must be finished before finishing indoor decoration.

5.3.2 Operation procedure for the airtightness test

Before ex-factory, cut-off valve for gas pipe and liquid pipe of outdoor unit is turned off. Please confirm that before operation.

Before test please smear a little corresponding lubricant oil at Blanking plug.and pipe terminal, and use two wrenches for fixing Blanking plug.

Do not allow to connect the pipeline of outdoor unit for test during airtightness test.

The system test pressure for R410A is 4.15MPa (3.0MPa for R22 refrigerant system). Nitrogen must be used as the medium for the airtightness test and the nitrogen should be dry. Increase pressure slowly for three steps:

Step 1: Increase pressure slowly to 0.5MPa, stop for 5min and then check the gas leakage. Big leakage may be found out;

Step 2: Increase pressure slowly to 1.5MPa, stop for 5min to check the airtightness. Small leakage may be found out;

Step 3: Increase pressure slowly to 4.15MPa for R410A slowly (3.0MPa for R22 refrigerant system), stop for 5min and perform the strength test. Minor leakage or sand hole may be found. Increase pressure to test pressure, keep it for 24h and observe whether the pressure is decreasing. If not, the pressure is qualified.

5.3.3 Cautions

- The test manometer range for R410A should be 4.5MPa above (3.5MPa above for R22 refrigerant system);
- Record the data on manometerk, ambient temperature and test time at the same time;
- Pressure modification: when temperature changes 1oC, the temperature will change 0.01MPa correspondingly.
- Pressure should be kept the same.
- If it needs to keep pressure for a long time, decrease the pressire lower than 0.55MPa pr below. Long-time high pressure can lead to leakage at the welding position, which may cause riskl.
- Before the airtightness for the pipeline of refrigerant is finished, do not allow to insulate and bundle the welding positions and connection position of bellmouth of indoor unit.

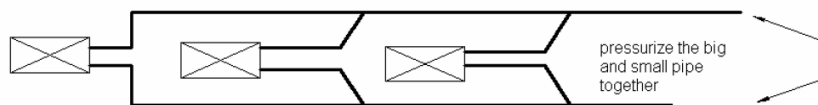

Note: Before airtightness test, all welding lines can't be insulated and bundled.

5.4 Fill and charge refrigerant

5.4.1 Filling procedure of regrigerant

- Calculate the additional volume of refrigerant

Additional volume of refrigerant $R=LA \times 54 \text{ g}$

$LA=L-50 \text{ m}$

$L= (12.7 \text{ length of liquid pipe}) \times 2+ (9.52 \text{ length of liquid pipe}) \times 1+ (6.4 \text{ length of liquid pipe}) \times 0.4$

When L is less than 50m, no need to add refrigerant

Examples:

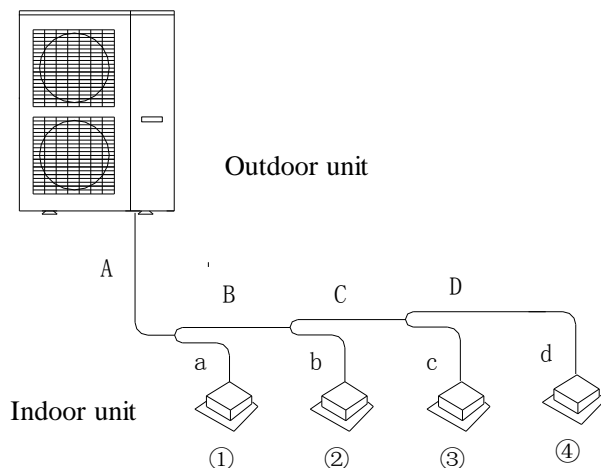

Indoor Unit:

No.	Model
Indoor Unit①	Cassette type GMV-ND71T/A-T
Indoor Unit②	Wall-mounted type GMV-N36G/A3A-K
Indoor Unit③	Duct type GMV-ND50PLS/A-T
Indoor Unit④	Duct type GMV-ND25PLS/A-T

Liquid Pipe:

No.	A	B	C	D
Diameter of pipe	$\phi 9.52$	$\phi 9.52$	$\phi 9.52$	$\phi 6.35$
Length	20m	10m	5m	5m
No.	a	b	c	d
Diameter of pipe	$\phi 9.52$	$\phi 6.35$	$\phi 6.35$	$\phi 6.35$
Length	10m	10m	10m	10m

Length of Liquid Pine:

$$\phi 9.52: A+B+C+a=20+10+5+10=45\text{m}$$

$$\phi 6.35: D+b+c+d=5+10+10+10=35\text{m}$$

$$L = (\phi 9.52 \text{ Length of liquid pipe}) \times 1 + (\phi 6.4 \text{ Length of liquid pipe}) \times 0.4 \\ = 45 \times 1 + 35 \times 0.4 = 59\text{m}$$

$$LA = L - 50 = 59 - 50 = 9 \text{ m}$$

$$\text{Additional volume of refrigerant } R = LA \times 54 = 9 \times 54 = 486 \text{ g}$$

b. Operation procedure for adding refrigerant

b1. Put the charging tank on the weightometer, record the reading and then calculate the data after charging refrigerant;

b2. Use charging conduct pipe to connect the double-ended manometer with governing valve and liquid-charging tank to the detection head of gas valve and liquid valve. Before connection, please release some refrigerant and then drain out the air inside the charging conduct pipe;

b3. Confirm that the gas valve and liquid valve for outdoor unit is at off status;

b4. When the unit hasn't been turned on, open the governing valve for the liquid-charging tank and then charge refrigerant from gas pipe and liquid pipe at the same time.

b5. Observe the data weightometer, close the valve after it is reached to requirement and then close the valve for liquid-charging tank;

b6. If the refrigerant can't be added completely, add it when turning on the unit. Charge refrigerant from the detection joint of cooling gas pipe or detection joint of gas valve.

c. Notice for filling refrigerant

c1. Calculate the section and length of cooling liquid pipe precisely for the precision refrigerant-charging volume.

c2. Measure the additional refrigerant volume precisely;

c3. R410A Invert to charge the R410A for ensuring the liquid-charging;

c4. When the temperature is low, heat the liquid-storage tank with hot water or hot wind for helping refrigerant-charging. However, prohibit use flame to heat the liquid-storage tank directly. Otherwise, it may cause personal injury or property damage due to explosion

5.5 Connection Pipe Size

If $L \geq 90\text{m}$ and $H \geq 15\text{m}$, then :

Model		Equivalent length L, Height difference between outdoor and indoor unit: H			
		L < 90m and H < 15m	L < 90m and H ≥ 15m	L ≥ 90m and H < 15m	L ≥ 90m and H ≥ 15m
GMV-280WL/A-X	L1 Gas pipe	φ 22.2	φ 22.2	φ 22.2	φ 28.6
	L1 Liquid pipe	φ 9.52	φ 9.52	φ 9.52	φ 12.7
GMV-250WL/A-X	L1 Gas pipe	φ 22.2	φ 22.2	φ 22.2	φ 28.6
	L1 Liquid pipe	φ 9.52	φ 9.52	φ 9.52	φ 12.7
GMV-224WL/A-X	L1 Gas pipe	φ 22.2	φ 22.2	φ 22.2	φ 22.2
	L1 Liquid pipe	φ 9.52	φ 9.52	φ 9.52	φ 12.7

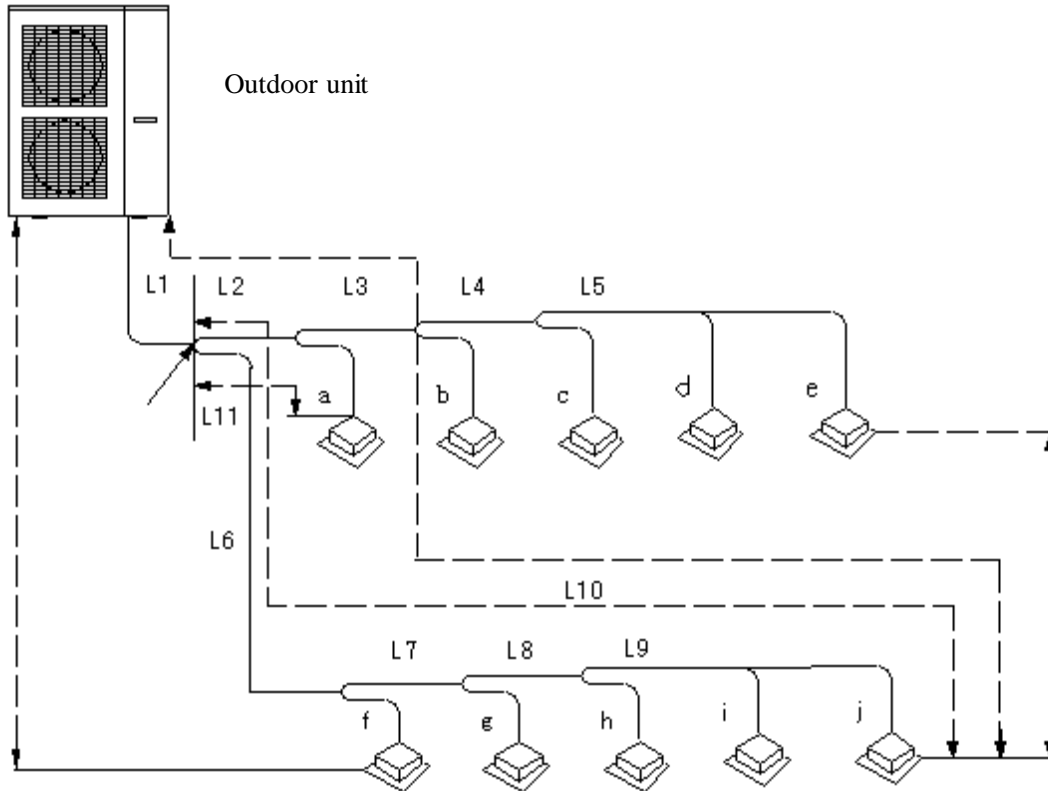

Notice: Equivalent length=Length of farthest fitting pipe+Equivalent length of brance(0.5m)

6 EXPLODED VIEW OF UNIT AND PARTS LIST

1) Model: GMV-224WL/A-X

Exploded view and parts list of outdoor unit:

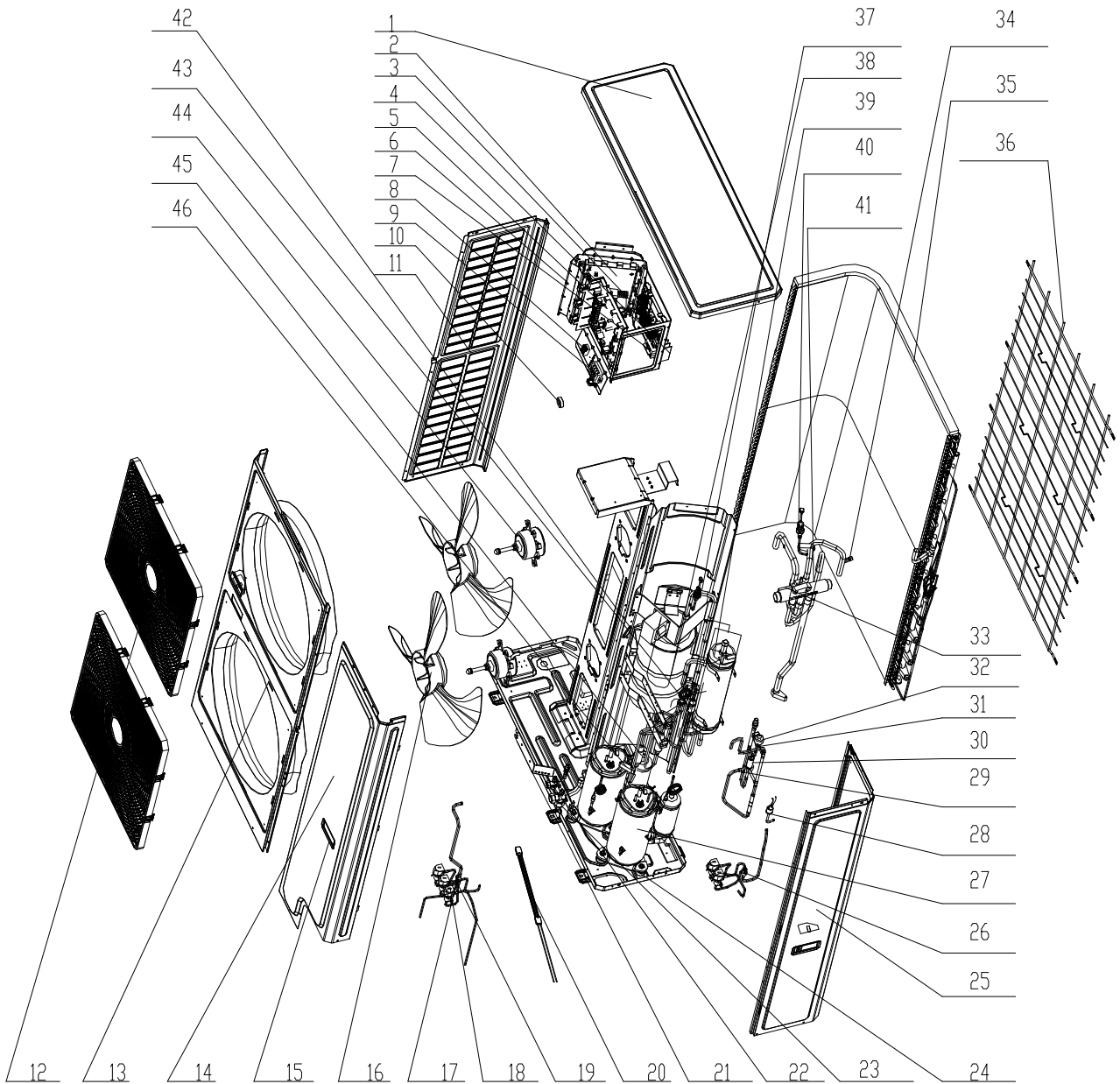

No.	Name of part	Quantity	Product code
1	Coping	1	01264100014
2	Main Board ZQCD	1	30224100001
3	Filter Board ZLBCD	1	30224100002
4	Radiator TL-002 15X11	1	49010252
5	Main Board WZCD3B	1	30223000007
6	Electric Box Assy GMV-280WL/A	1	01394100069
7	Filter Board 60A/800V(DF60BA80)(Three-phase)	1	46010608
8	Terminal Board(2bit)	1	42011154
9	Terminal Board (4bit) T480C	1	42011043
10	Magnetic Ring (IV 38X13X19)	3	49010109
11	Left Side Plate	1	01314100024P
12	Front Grill	2	01574100006
13	Cabinet	1	01514100003P
14	Front Side Plate	1	01314100026P
15	Handle(apricot gray)	3	26235253
16	Axial Flow Fan (primary color)	2	10335010
17	Electromagnetic Valve	5	43000054
18	Magnet Coil	1	4300040032
19	Current Divider(Y-pipe)	1	03410101
20	Electrical Heater(Compressor)	2	765152123
21	Cut-off Valve 3/8(R410A)	1	07330000002
22	Cut-off Valve 3/4(R410A)	1	07330000001
23	Installation Plate Assy (valve)	1	01324100017
24	Compressor Gasket ZE8.639.601	6	76710247
25	Rear Side Plate	1	01314100025P
26	Balancing Oil Tube Assy	1	04224100203
27	Compressor and fittings QXAS-D32zX050	2	00204100005
28	Pressure Protect Switch(with out going line)	1	4602001535
29	Electric Expand Valve Fitting	1	43044100059
30	Discharge Charge Valve	1	07334100002

31	Electronic Expansion Valve UKV-32D178	1	07334390
32	Electric Expand Valve Fitting UKV	1	4304413219
33	Magnet Coil	1	43040004
34	Nozzle for Adding Freon (R407C)	1	06120012
35	Condenser Assy	1	01124100097
36	Rear Grill	1	26904100078
37	4-way Valve (SHF-20A-46/DSF-20-R410A)	1	43000338
38	Sensor(High Pressure)	1	322101032
39	Oil Separator	1	07424100027
40	Gas Liquid Separator	1	07424100030
41	Sensor(Low Pressure)	1	322101002
42	Cable Cross Loop	1	76515202
43	Strainer(Bidirection Strainer)	1	07220019
44	Fan Motor SWZ150B	2	1570280201
45	One Way Valve	1	07130101
46	Tube Clip	1	021400054
47	Current Divider(Y-Pipe)	1	03410101
Note: Above data is subject to change without notice, please refer the SP in global service website.			

2) Model:GMV-250WL/A-X,GMV-280WL/A-X
Exploded view and parts list of outdoor unit:

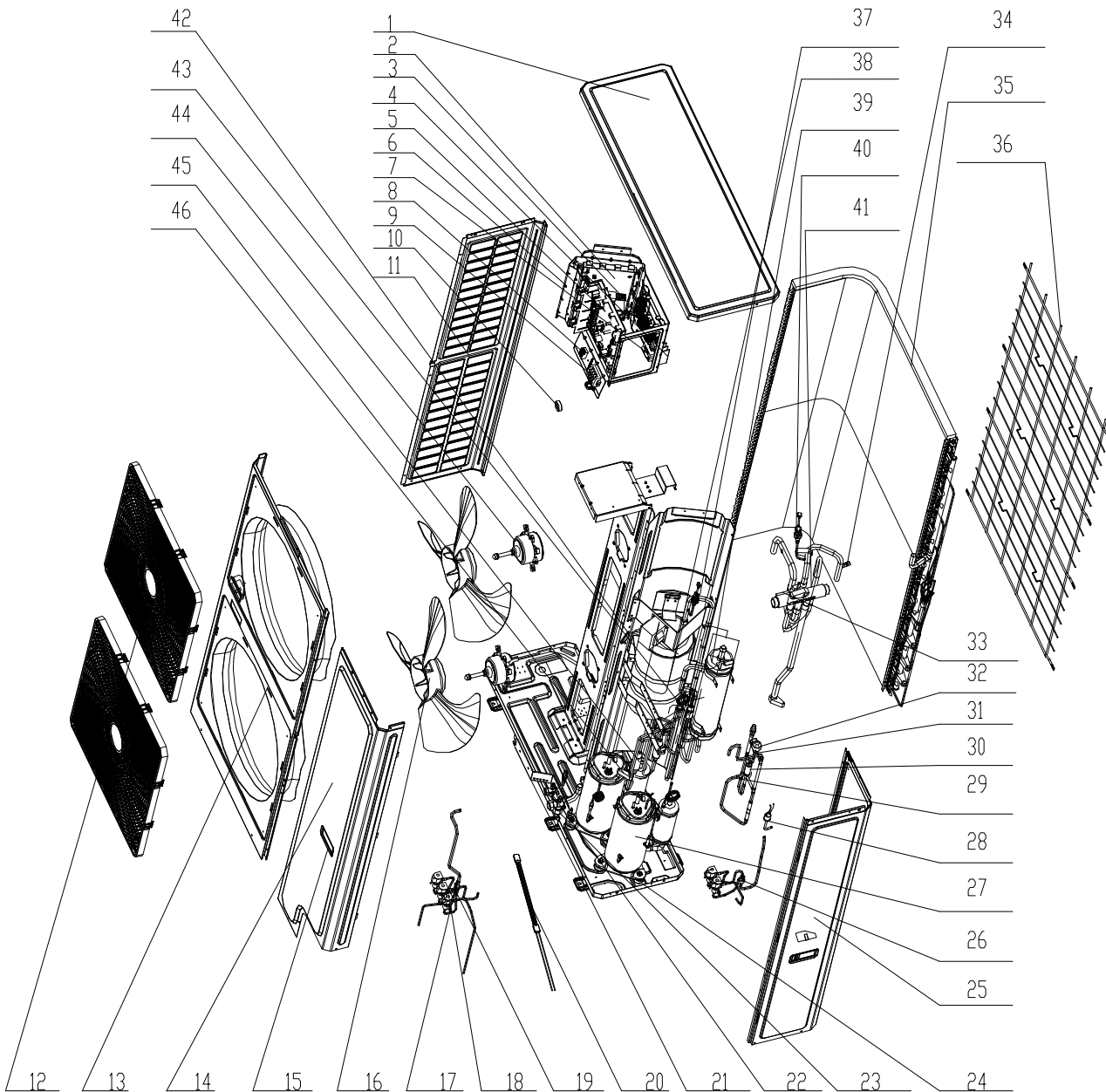

No.	Name of part	Quantity	Product code
1	Coping	1	01264100014
2	Main Board ZQCD	1	30224100001
3	Filter Board ZLBCD	1	30224100002
4	Radiator TL-002 15X11	1	49010252
5	Main Board WZCD3B	1	30223000007
6	Electric Box Assy GMV-280WL/A	1	01394100069
7	Filter Board 60A/800V(DF60BA80) (Three-phase)	1	46010608
8	Terminal Board (2bit)	1	42011154
9	Terminal Board (4bit) T480C	1	42011043
10	Magnetic Ring (IV 38X13X19)	3	49010109
11	Left Side Plate	1	01314100024P
12	Front Grill	2	01574100006
13	Cabinet	1	01514100003P
14	Front Side Plate	1	01314100026P
15	Handle (Apricot Gray)	3	26235253
16	Axial Flow Fan (Primitive Colors)	2	10335010
17	Electromagnetic Valve	5	43000054
18	Magnet Coil	1	4300040032
19	Current Divider(Y-pipe)	1	03410101
20	Electrical Heater(Compressor)	2	76518732
21	Cut-off Valve 3/8(R410A)	1	07330000002
22	Cut-off Valve 3/4(R410A)	1	07330000001
23	Installation plate Assy(Valve)	1	01324100017
24	Compressor Gasket ZE8.639.601	6	76710247
25	Rear Side Plate	1	01314100025P
26	Balancing Oil Tube Assy	1	04224100203
27	Compressor and Fittings QXAS-F428zX050B	2	00204100005
28	Pressure Protect Switch (with out going line)	1	4602001535
29	Electric Expand Valve Fitting	1	43044100059
30	Discharge Charge Valve	1	07334100002
31	Electronic Expansion Valve UKV-32D178	1	07334390
32	Electric Expand Valve Fitting UKV	1	4304413219
33	Magnet Coil	1	43040004
34	Nozzle for Adding Freon (R407C)	1	06120012
35	Condenser Assy	1	01124100097
36	Rear Grill	1	26904100078
37	4-way Valve (8HP)(R410A) STF-0714G	1	43000413

38	Sensor(Hign Pressure)	1	322101032
39	Oil Separator	1	07424100027
40	Gas Luquid Separator	1	07424100030
41	Sensor(Low Pressure)	1	322101002
42	Cable Cross Loop	1	76515202
43	Strainer (Bidirection Strainer)	1	07220019
44	Fan Motor SWZ150B	2	1570280201
45	One Way Valve	1	07130101
46	Tube Cipe	1	021400054
47	Current Divider (Y-pipe)	1	03410101
Note: Above data is subject to change without notice, please refer the SP in global service website.			



JF00302358

GREE ELECTRIC APPLIANCES, INC. OF ZHUHAI

Add: West Jinji Rd, Qianshan, Zhuhai, Guangdong, China, 519070

Tel: (+86-756) 8522218 Fax: (+86-756) 8669426

E-mail: gree@gree.com.cn www.gree.com

For continuous improvement in the products, Gree reserves the right to modify the product specification and appearance in this manual without notice and without incurring any obligations.